

cisal
TOP STYLE

Top Style 2008

OLTRE LA QUALITÀ

Quando tecnologia e scelta di prodotti superano i traguardi della qualità, è ora di andare oltre. È il momento dell'eccellenza. L'alto di gamma Cisal la interpreta in una grande varietà di stili. Liberi, come sempre.

BEYOND THE QUALITY

When technology and products' choice overcome quality goals, it is time to go over. It is the moment of excellence. Cisal reads high quality with a wide range of styles. Free styles as always.



BIEN PLUS QUE LA QUALITE

Parce que la technologie permet une évolution toujours plus poussée des produits, la qualité n'est pas le seul élément à considérer. L'excellence de la culture et du haut de gamme. Cisal à sa façon le conjugue dans un concert de variété et de style libre.

JENSEITS DER QUALITÄT

Wenn Technologie und Wissenschaft die Qualitätsziele erreicht haben, ist es Zeit sich auf anderes zu konzentrieren. Dies ist der Moment des Hochwertigen. Cisal verbindet hohe Qualität mit einer weiten Bandbreite an hochwertigem Design. Freies Design, wie immer.

MÁS ALLÁ DE LA CALIDAD

Cuando tecnología y selección de los productos superan las metas de la calidad, ya ha venido el tiempo de ir más allá. Es el momento de la excelencia. La gama alta de Cisal los interpreta en una grande variedad de estilos. Libres como siempre.

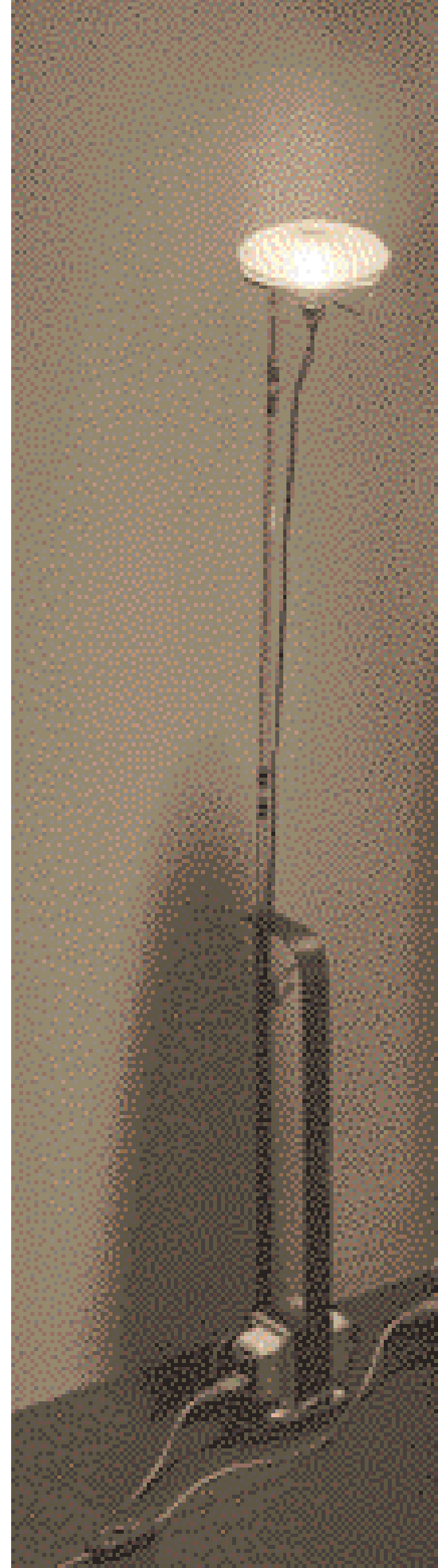

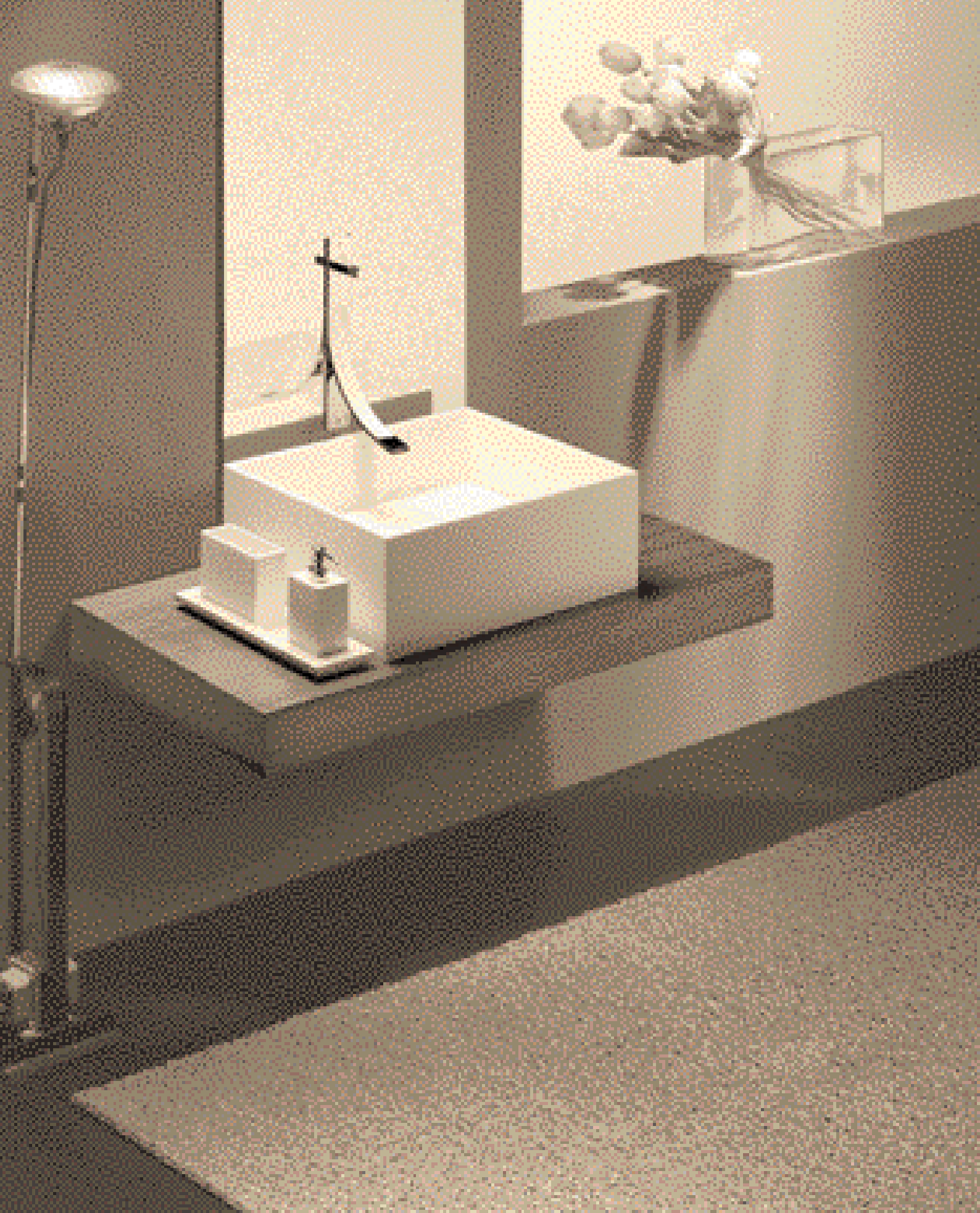

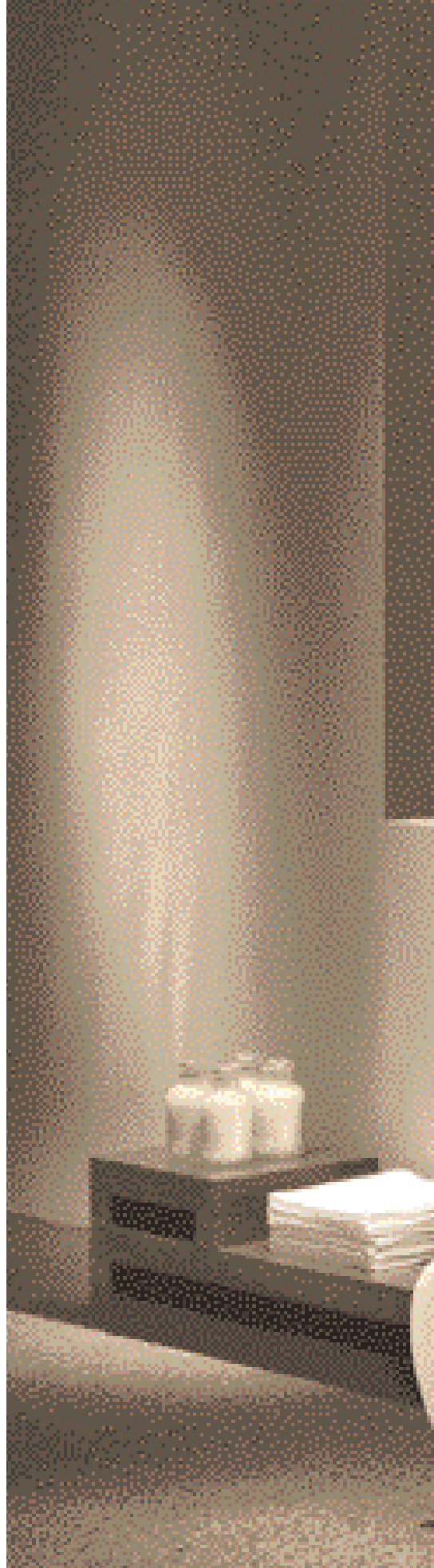







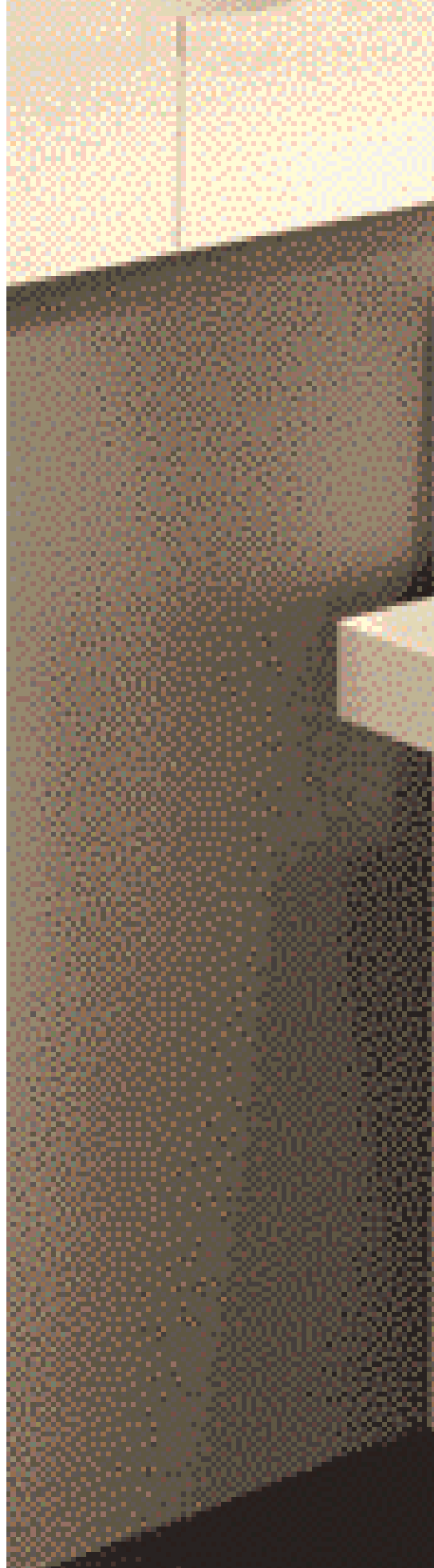

















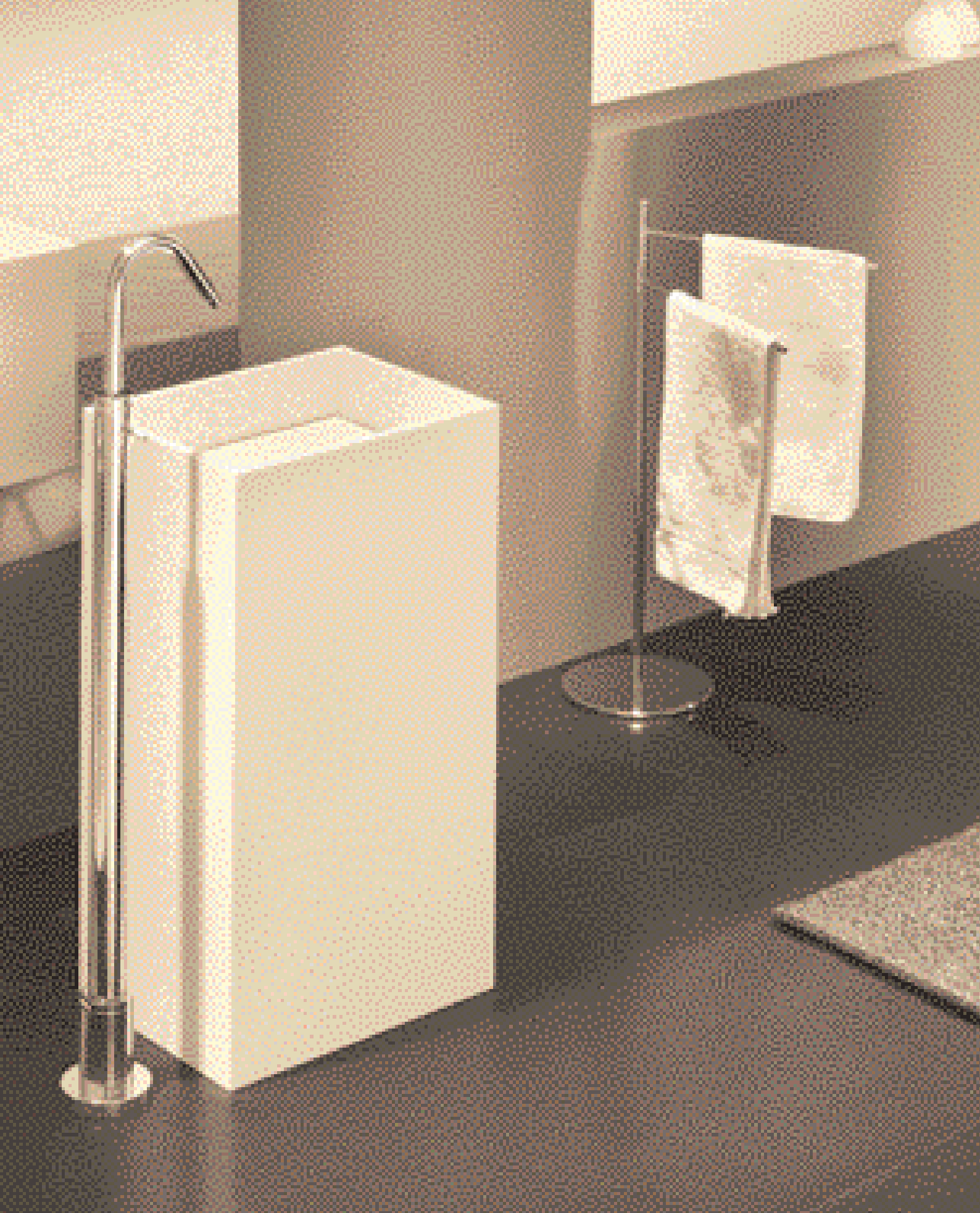



































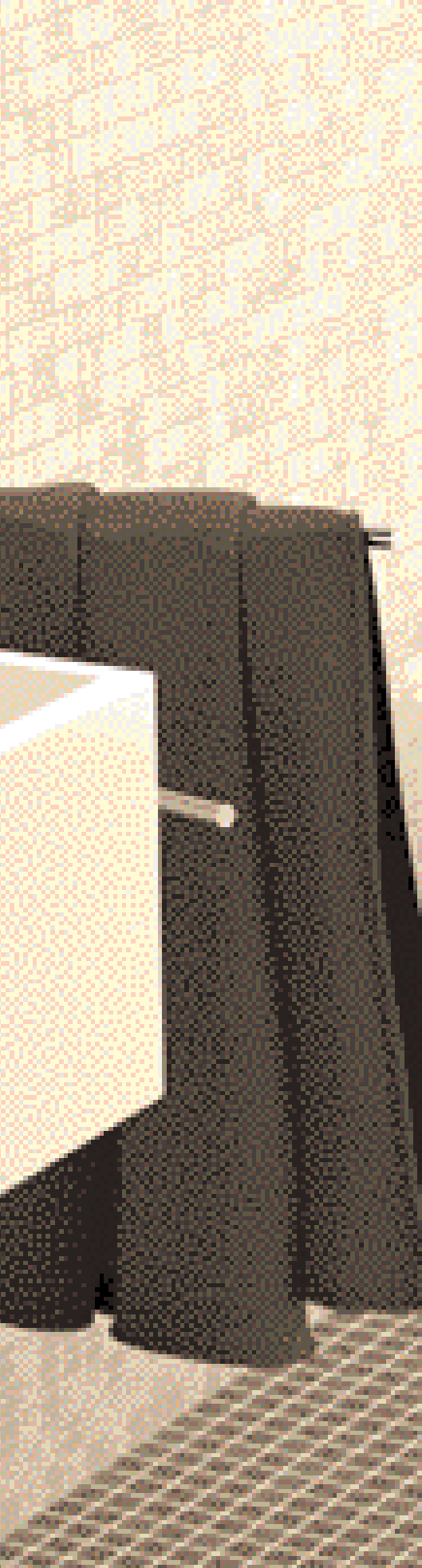









WAVE

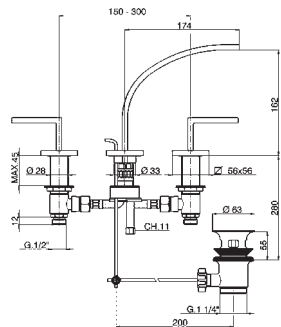

WA 00102 O

Batteria lavabo
Wash basin mixer
Mélangeur lavabo
3 Loch-Waschtischbatterie
Batería lavabo

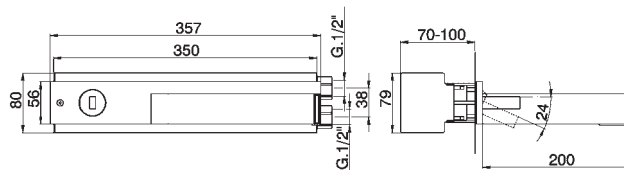

WA 00251 O

Monocomando lavabo incasso
Single lever concealed wash-basin mixer
Mitigeur lavabo encastré
Einhand-Waschtischbatterie
Monomando lavabo para empotrar

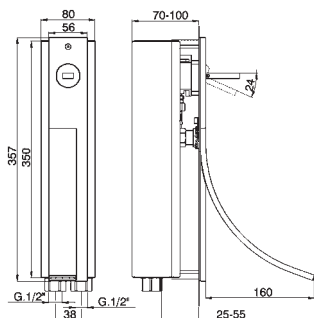

WA 00351 O

Monocomando lavabo / bidet incasso
Single lever wash-basin / bidet
concealed mixer
Mitigeur lavabo / bidet encastré
Einhand UP-Waschtisch-Bidetbatterie
Monomando lavabo / bidé para empotrar

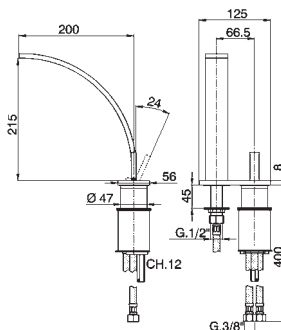

WA 00651 O

Monocomando lavabo
Single lever wash-basin mixer
Mitigeur lavabo
Einhand-Waschtischbatterie
Monomando lavabo

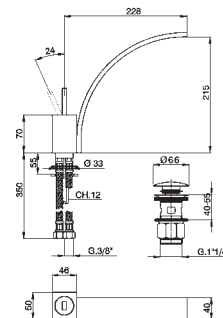

WA 00051 O

Monocomando lavabo
Single lever wash-basin mixer
Mitigeur lavabo
Einhand-Waschtischbatterie
Monomando lavabo

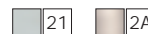

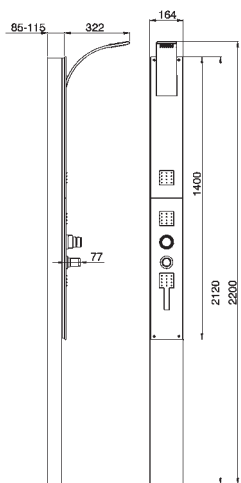

WA 00500 0

Pannello doccia
Complete shower column
Colonne de douche complète
Standbrause Komplett
Panel ducha



STEP

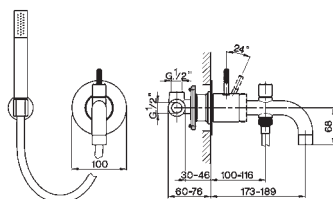

ST 00110 O

Monocomando vasca
Single lever bath mixer
Mitigeur bain/douche
Einhand-Badebatte DN 15
Monomando bañera

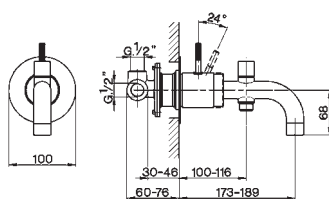

ST 00113 O

Monocomando vasca
Single lever bath mixer
Mitigeur bain/douche
Einhand-Badebatte DN 15
Monomando bañera

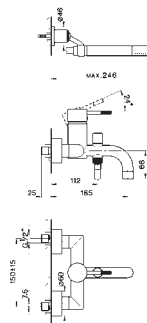

LS 00012 O

Monocomando vasca
Single lever bath mixer
Mitigeur bain/douche
Einhand-Badebatte
Monomando bañera

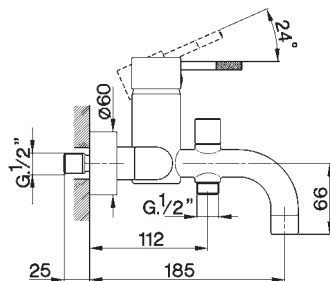
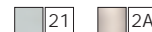

LS 00015 O

Monocomando vasca
Single lever bath mixer
Mitigeur bain/douche
Einhand-Badebatte
Monomando bañera

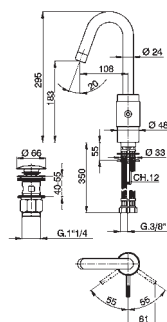

ST 00051 O

Monocomando lavabo
Single lever wash-basin mixer
Mitigeur lavabo
Einhand-Waschtischbatte
Monomando lavabo

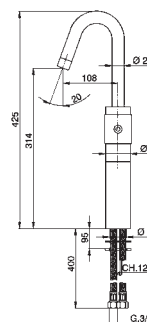

ST 00254 O

Monocomando lavabo
Single lever wash-basin mixer
Mitigeur lavabo
Einhand-Waschtischbatte
Monomando lavabo



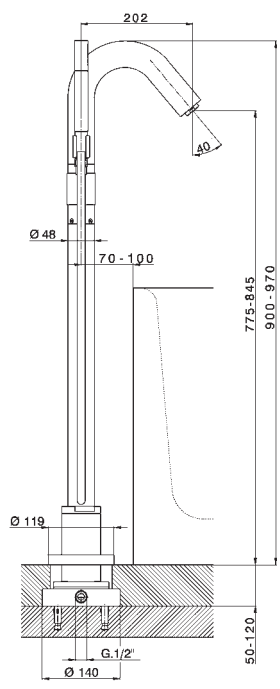

ST 00420 O
 Colonna vasca
 Bath column
 Colonne bain
 Standbadebatterie
 Columna de bañera

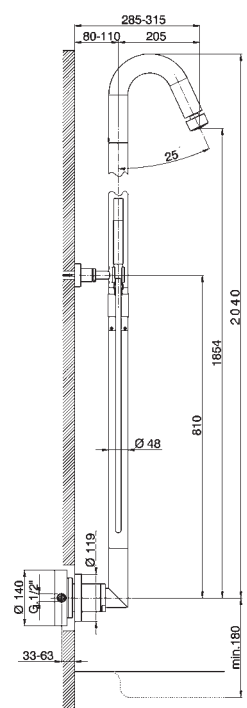

ST 00505 O
 Colonna doccia
 Shower column
 Colonne douche
 Standbrause
 Columna de ducha

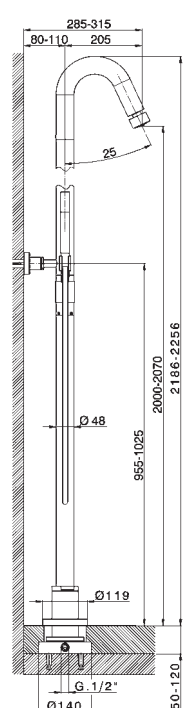

ST 00510 O
 Colonna doccia
 Shower column
 Colonne douche
 Standbrause
 Columna de ducha de suelo



STEP

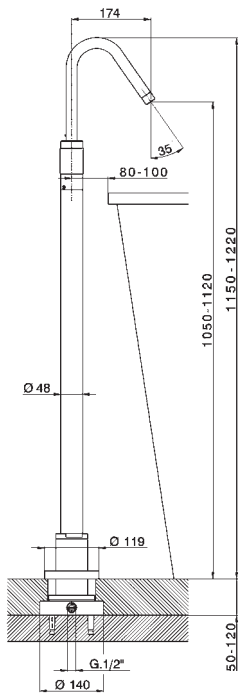

ST 00451 0
Colonna lavabo
Wash-basin column
Colonne lavabo
Standwaschtisch
Columna de lavabo

PUMPY

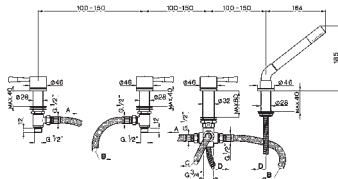

PU 00029 0

Batteria bordo vasca a 4 fori
Deck-mounted 4-hole bath mixer
Mélangeur B/D 4-trous sur gorge
4 Loch - Badebatterie
Batería borde bañera de 4 agujeros

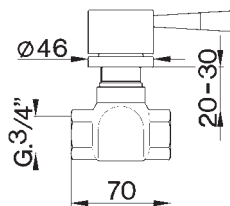

PU 00030 3

Rubinetto incasso
Concealed valve
Robinet à encastrer
UP-Ventil
Grifo para empotrar 3/4"

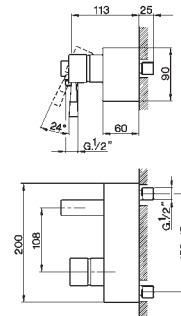

PU 00044 1

Monocomando doccia esterno
Single lever wall-mounted shower mixer
Mitigeur douche mural
Einhand-Brausebatterie
Monomando ducha exterior

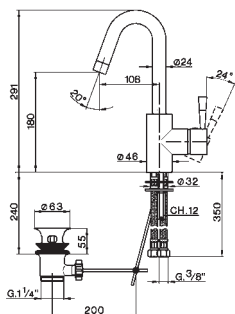

PU 00050 0

Monocomando lavabo
Single lever wash-basin mixer
Mitigeur lavabo
Einhand-Waschtischbatterie
Monomando lavabo

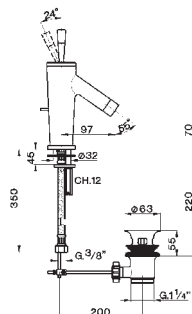

PU 00051 0

Monocomando lavabo
Single lever wash-basin mixer
Mitigeur lavabo
Nicht in Deutschland verfügbar
Monomando lavabo

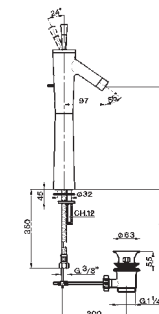

PU 00052 0

Monocomando lavabo
Single lever wash-basin mixer
Mitigeur lavabo
Einhand-Waschtischbatterie
Monomando lavabo



PUMPY

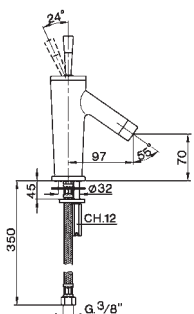

PU 00054 0

Monocomando lavabo
Single lever wash-basin mixer
Mitigeur lavabo
Nicht in Deutschland verfügbar
Monomando lavabo

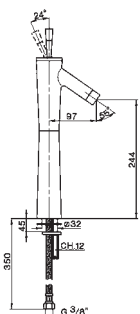

PU 00254 0

Monocomando lavabo
Single lever wash-basin mixer
Mitigeur lavabo
Einhand Waschtischbatterie
Monomando lavabo

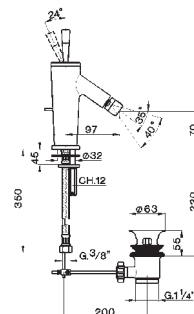

PU 00055 0

Monocomando bidet
Single lever bidet mixer
Mitigeur bidet
Nicht in Deutschland verfügbar
Monomando bidé

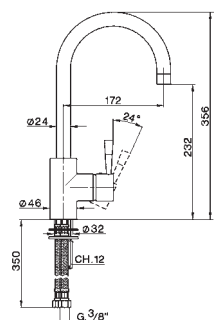

PU 00053 0

Monocomando lavello
Single lever sink mixer
Mitigeur évier
Einhand-Spültischbatterie
Monomando fregadero

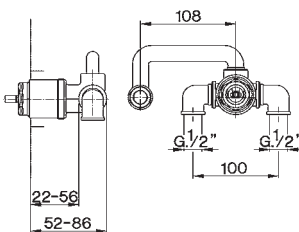

ZA 00651 0

Corpo monocomando lavabo incasso
Concealed single lever wash-basin mixer
Corps mitigeur lavabo encastré
Einhand-UP-Waschtischbatterie
Cuerpo monomando lavabo para empotrar

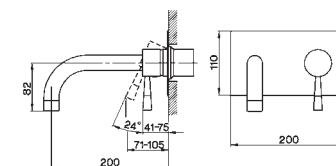

PU 00551 0

Parte esterna monocomando lavabo incasso
Visible parts for single lever wash-basin concealed mixer
Façade seule pour mitigeur lavabo encastré
UP-Einhand-Waschtischbatterie - Fertigmontageset
Parte exterior monomando lavabo para empotrar



PUMPY

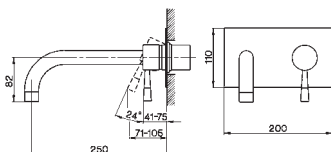

PU 00551 1

Parte esterna monocomando lavabo incasso
Visible parts for single lever
wash-basin concealed mixer
Façade seule pour mitigeur lavabo encastré
UP-Einhand-Waschtischbatterie
- Fertigmontageset
Parte exterior monomando lavabo
para empotrar

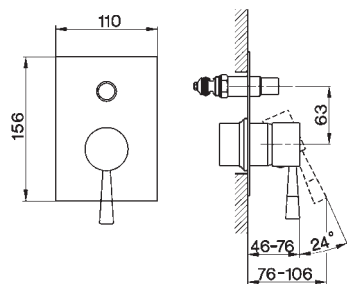

PU 00210 0

Parte esterna monocomando
vasca-doccia incasso
Visible parts for single lever
bath-shower mixer
Façade seule pour mitigeur
bain/douche encastré
Einhand-UP-Wannenfüll-u.
Brausebatterie - Fertigmontageset
Parte exterior monomando bañera-
ducha para empotrar

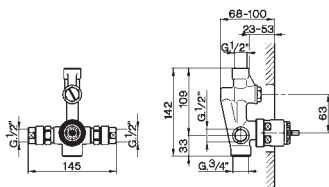

ZA 00421 0

Corpo monocomando vasca-doccia incasso
Concealed single lever bath-shower mixer
Corps seul mitigeur bain/douche encastré
Einhand-UP-Wannenfüll-u. Brausebatterie -
Wandeinbausatz
Cuerpo monomando bañera/ducha
para empotrar

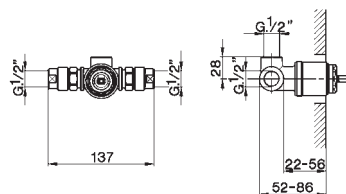

ZA 00431 0

Corpo monocomando doccia incasso
Concealed single lever shower mixer
Corps mitigeur douche encastré
Einhand-UP-Brausebatterie
- Wandeinbausatz
Cuerpo monomando ducha
para empotrar

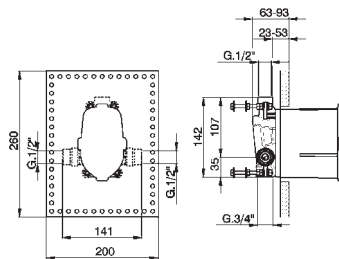

ZA 00421 3

Corpo monocomando vasca-doccia
incasso
Concealed single lever bath-shower mixer
Corps seul mitigeur bain/douche
encastré
Einhand-UP-Wannenfüll-u.
Brausebatterie - Wandeinbausatz
Cuerpo monomando bañera/ducha
para empotrar

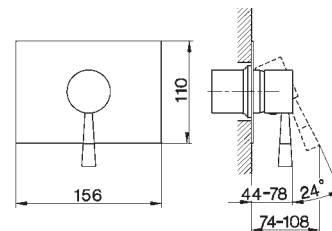

PU 00300 0

Parte esterna monocomando doccia
incasso
Visible parts for single lever shower
mixer
Façade seule pour mitigeur douche
encastré
UP-Brausebatterie - Fertigmontageset
Parte exterior monomando ducha
para empotrar



PUMPY

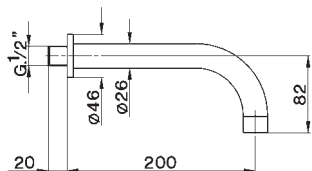

ZA 00125 0

Bocca di erogazione
Bath spout
Bec déverseur
Wanneneinlauf
Caño de erogación

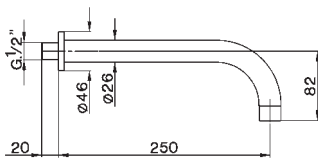

ZA 00125 1

Bocca di erogazione
Bath spout
Bec déverseur
Wanneneinlauf
Caño de erogación

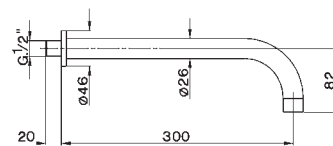

ZA 00125 2

Bocca di erogazione
Bath spout
Bec déverseur
Wanneneinlauf
Caño de erogación

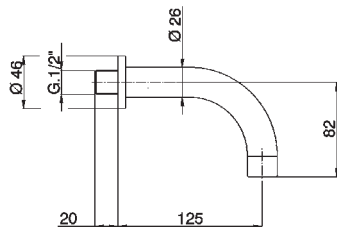
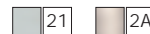

ZA 00125 3

Bocca di erogazione
Bath spout
Bec déverseur
Wanneneinlauf
Caño de erogación

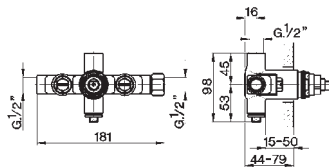

HY 00018 0

Corpo miscelatore termostatico
incasso
Thermostatic concealed mixer
Partie encastrée pour mitigeur
thermostatique
UP-Thermostatbatterie
Cuerpo mezclador termostático para
empotrar

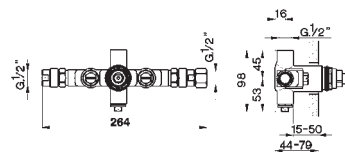

HY 00018 1

Corpo miscelatore termostatico
incasso
Thermostatic concealed mixer
Partie encastrée pour mitigeur
thermostatique
UP-Thermostatbatterie
Cuerpo mezclador termostático para
empotrar

PUMPY

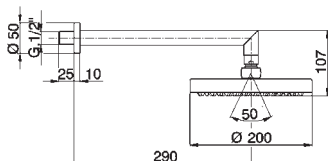

DS 01319 0

Braccio doccia
Shower arm
Bras de douche
Brausearm
Brazo ducha

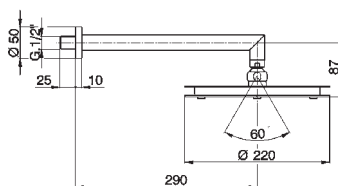

DS 01314 0

Braccio doccia Disco
Disco shower arm
Bras de douche Disco
Brausearm Disco
Brazo ducha Disco

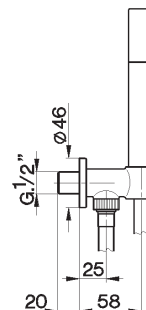

LS 00303 3

Supporto doccia incasso
Wall-mounted shower holder
Support mural
Wandhalter
Soporte ducha para empotrar

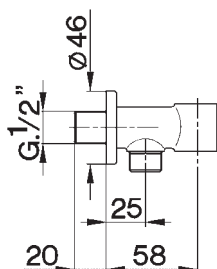
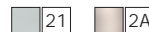

LS 00364 3

Supporto alimentazione a parete
Wall elbow
Raccord mural
Wandanschlussbogen
Soporte alimentación de pared

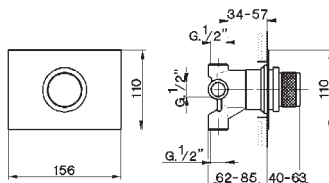

LS 00027 0

Deviatore a dischi ceramici 4 vie
4-way ceramic discs diverter
Inverseur à disques céramiques 4 voies
4-Wege-UP-Umstellung
Desviador de discos cerámicos 4 vías

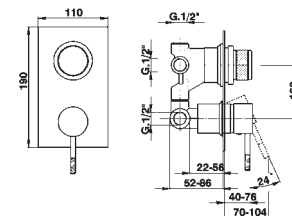

LS 00028 0

Miscelatore monocomando incasso
con deviatore a dischi ceramici
Concealed mixer with ceramic
discs diverter
Mitigeur encastré
avec inverseur à disques céramiques
UP-Umstellung
Mezclador monomando para empotrar
con desviador de discos cerámicos

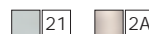

PUMPY

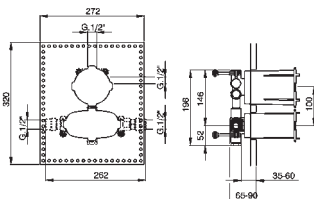

ZA 01840 0

Corpo incasso miscelatore
termostatico con deviatore a dischi
ceramici 3 vie
Thermostatic concealed mixer
with 3 ways ceramic discs diverter
Corps encastré mitigeur
thermostatique avec inverseur à
disques céramiques à 3 voies
UP Thermostatbatterie mit Umsteller
mit keramischen Scheiben 3 Wege
Cuerpo para empotrar mezclador
termostático con desviador de discos
cerámicos 3 vías

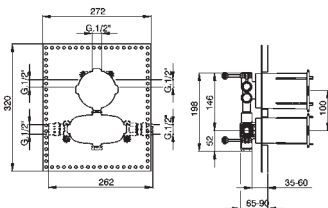

ZA 01850 0

Corpo incasso miscelatore
termostatico con deviatore a dischi
ceramici 4 vie
Thermostatic concealed mixer
with 4 ways ceramic discs diverter
Corps encastré mitigeur
thermostatique avec inverseur à
disques céramiques à 4 voies
UP Thermostatbatterie mit Umsteller
mit keramischen Scheiben 4 Wege
Cuerpo para empotrar mezclador
termostático con desviador de discos
cerámicos 4 vías

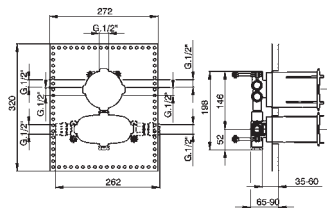

ZA 01860 0

Corpo incasso miscelatore
termostatico con deviatore a dischi
ceramici 6 vie
Thermostatic concealed mixer
with 6 ways ceramic discs diverter
Corps encastré mitigeur
thermostatique avec inverseur à
disques céramiques à 6 voies
UP Thermostatbatterie mit Umsteller
mit keramischen Scheiben 6 Wege
Cuerpo para empotrar mezclador
termostático con desviador de discos
cerámicos 6 vías

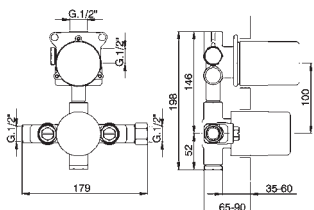

ZA 01840 1

Corpo incasso miscelatore
termostatico con deviatore a dischi
ceramici 3 vie
Thermostatic concealed mixer
with 3 ways ceramic discs diverter
Corps encastré mitigeur
thermostatique avec inverseur à
disques céramiques à 3 voies
UP Thermostatbatterie mit Umsteller
mit keramischen Scheiben 3 Wege
Cuerpo para empotrar mezclador
termostático con desviador de discos
cerámicos 3 vías

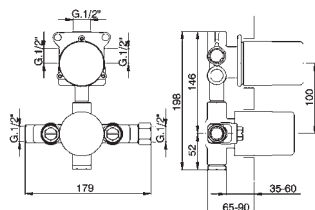

ZA 01850 1

Corpo incasso miscelatore
termostatico con deviatore a dischi
ceramici 4 vie
Thermostatic concealed mixer
with 4 ways ceramic discs diverter
Corps encastré mitigeur
thermostatique avec inverseur à
disques céramiques à 4 voies
UP Thermostatbatterie mit Umsteller
mit keramischen Scheiben 4 Wege
Cuerpo para empotrar mezclador
termostático con desviador de discos
cerámicos 4 vías

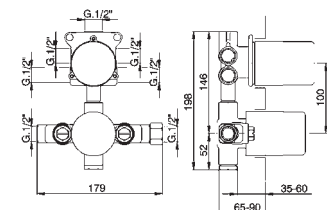

ZA 01860 1

Corpo incasso miscelatore
termostatico con deviatore a dischi
ceramici 6 vie
Thermostatic concealed mixer
with 6 ways ceramic discs diverter
Corps encastré mitigeur
thermostatique avec inverseur à
disques céramiques à 6 voies
UP Thermostatbatterie mit Umsteller
mit keramischen Scheiben 6 Wege
Cuerpo para empotrar mezclador
termostático con desviador de discos
cerámicos 6 vías

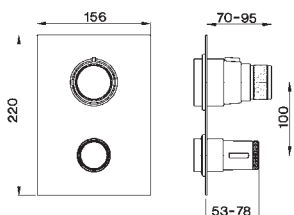

LS 01840 3

Miscelatore termostatico incasso con deviatore a dischi ceramici 3 vie per Art. ZA018400 e art. ZA018401
 Thermostatic concealed mixer with 3 ways ceramic discs diverter for Art. ZA018400 e art. ZA018401
 Mitigeur thermostatique encastré avec inverseur à disques céramiques 3 voies pour art. ZA018400 e art. ZA018401
 Thermostat Batterie mit 3 Wegen UP Umstellung für Art. ZA018400 und art. ZA018401
 Mezclador termostático para empotrar con desviador discos cerámicos 3 vías para art. ZA018400 e art. ZA018401

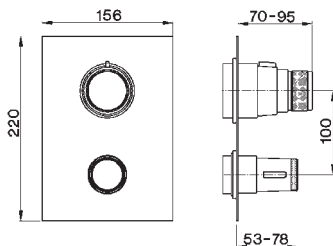

LS 01850 3

Miscelatore termostatico incasso con deviatore a dischi ceramici 4 vie per Art. ZA018500 e art. ZA018501
 Thermostatic concealed mixer with 4 ways ceramic discs diverter for Art. ZA018500 e art. ZA018501
 Mitigeur thermostatique encastré avec inverseur à disques céramiques 4 voies pour art. ZA018500 e art. ZA018501
 Thermostat Batterie mit 4 Wegen UP Umstellung für Art. ZA018500 und art. ZA018501
 Mezclador termostático para empotrar con desviador discos cerámicos 4 vías para art. ZA018500 e art. ZA018501

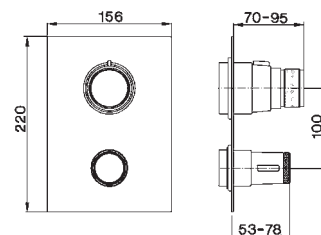

LS 01860 3

Miscelatore termostatico incasso con deviatore a dischi ceramici 6 vie per Art. ZA018600 e art. ZA018601
 Thermostatic concealed mixer with 6 ways ceramic discs diverter for Art. ZA018600 e art. ZA018601
 Mitigeur thermostatique encastré avec inverseur à disques céramiques 6 voies pour art. ZA018600 e art. ZA018601
 Thermostat Batterie mit 6 Wegen UP Umstellung für Art. ZA018600 und art. ZA018601
 Mezclador termostático para empotrar con desviador discos cerámicos 6 vías para art. ZA018600 e art. ZA018601

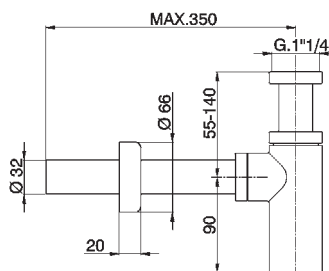
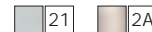

ZA 00404 2

Sifone minimale
 Siphon minimal
 Siphon minimal
 Siphon minimale
 Sifón Minimal

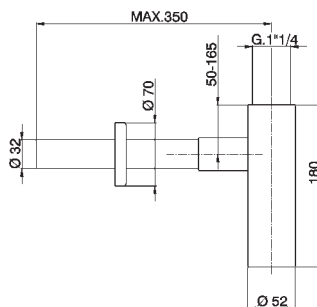

ZA 00407 0

Sifone
 Siphon
 Siphon
 Siphon
 Sifón

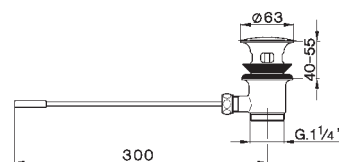

ZA 00580 0

Scarico automatico
 Automatic pop-up waste
 Vidage automatique
 Automatische Ablaufgarnitur
 Desague automático



PUMPY

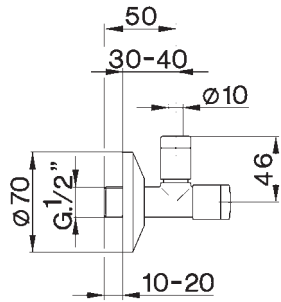

ZA 00290 O

Rubinetto d'alimentazione
Angle supply
Robinet d'alimentation
Eckventil
Grifo de alimentación

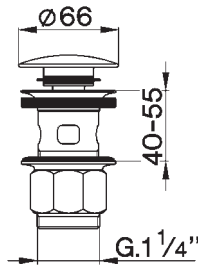

ZA 00162 O

Piletta Rapid 1"1/4 per lavabo
Waste Rapid 1"1/4 for basin
Crépine Rapid 1"1/4 pour lavabo
Ablauf Rapid 1"1/4 für Waschtisch
Válvula Rapid 1"1/4 para lavabo



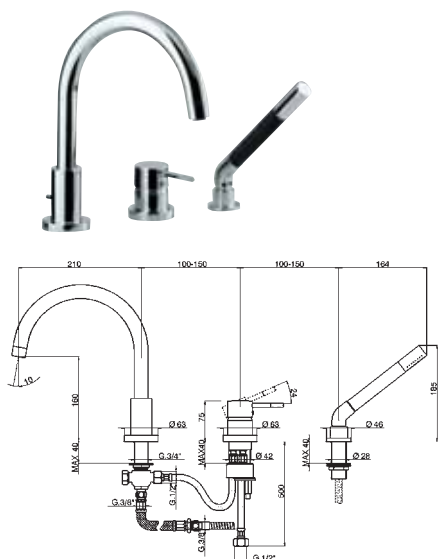

LS 00126 0
 Batteria bordo vasca a 3 fori
 Deck-mounted 3-hole bath mixer
 Mélangeur B/D 3-trous sur gorge
 3 Loch - Badebatterie
 Batería borde bañera de 3 agujeros

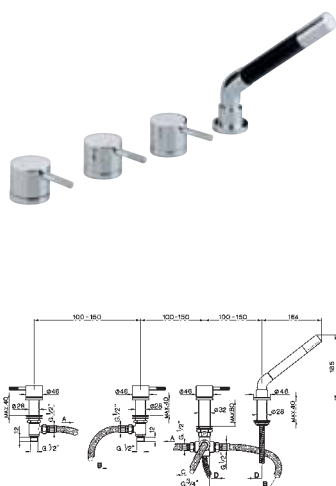

LS 00029 0
 Batteria bordo vasca a 4 fori
 Deck-mounted 4-hole bath mixer
 Mélangeur B/D 4-trous sur gorge
 4 Loch - Badebatterie
 Batería borde bañera de 4 agujeros

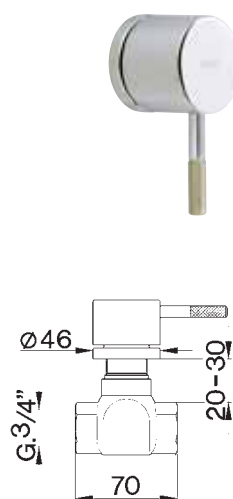

LS 00030 0
 Rubinetto incasso
 Concealed valve
 Robinet à encastrer
 UP-Ventil
 Grifo para empotrar 3/4"

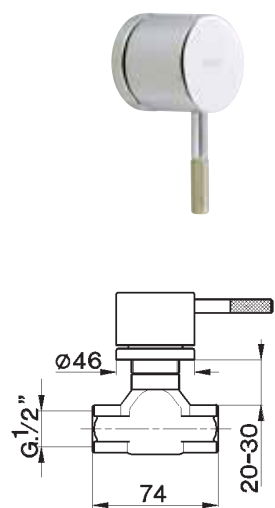
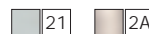

LS 00031 0
 Rubinetto incasso
 Concealed valve
 Robinet à encastrer
 UP-Ventil
 Grifo para empotrar

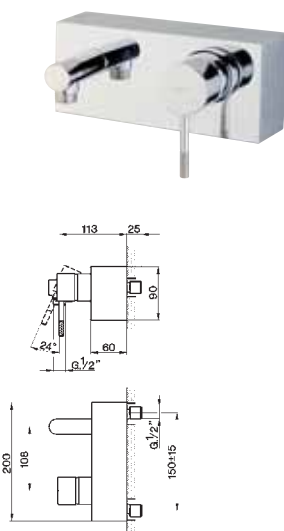

LS 00044 1
 Monocomando doccia esterno
 Single lever wall-mounted
 shower mixer
 Mitigeur douche mural
 Einhand-Brausebatterie
 Monomando ducha exterior

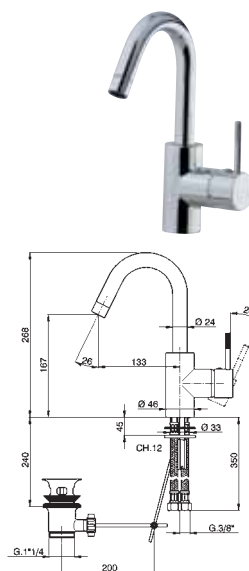

LS 00050 0
 Monocomando lavabo
 Single lever wash-basin mixer
 Mitigeur lavabo
 Einhand-Waschtischbatterie
 Monomando lavabo



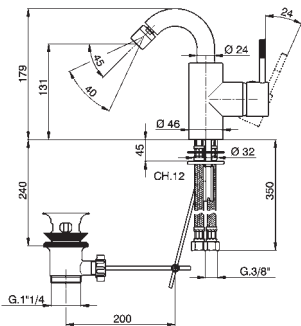

LS 00255 O
 Monocomando bidet
 Single lever bidet mixer
 Mitigeur bidet
 Einhand-Bidetbatterie
 Monomando bidé

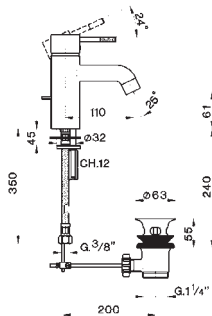

LS 00051 O
 Monocomando lavabo
 Single lever wash-basin mixer
 Mitigeur lavabo
 Einhand-Waschtischbatterie
 Monomando lavabo

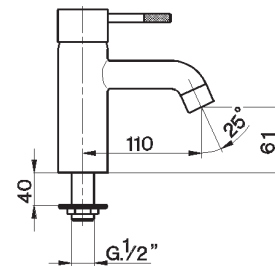

LS 00090 O
 Monoforo lavamani
 Pillar tap
 Robinet de comptoir
 Standventil
 Monobloc lavamanos

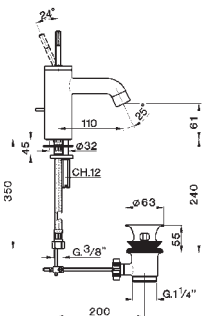
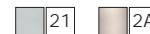

LS 00151 O
 Monocomando lavabo
 Single lever wash-basin mixer
 Mitigeur lavabo
 Einhand-Waschtischbatterie
 Monomando lavabo

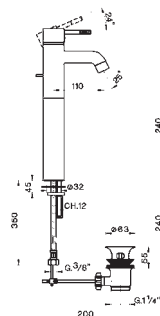

LS 00052 O
 Monocomando lavabo
 Single lever wash-basin mixer
 Mitigeur lavabo
 Einhand-Waschtischbatterie
 Monomando lavabo

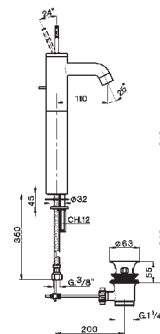

LS 00152 O
 Monocomando lavabo
 Single lever wash-basin mixer
 Mitigeur lavabo
 Einhand-Waschtischbatterie
 Monomando lavabo

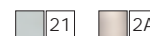

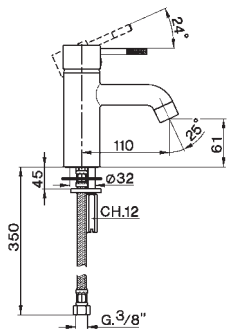

LS 00054 O
 Monocomando lavabo
 Single lever wash-basin mixer
 Mitigeur lavabo
 Einhand-Waschtischbatte
 Monomando lavabo

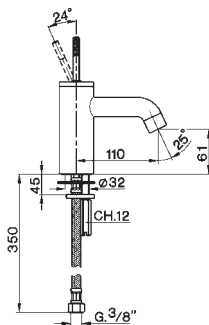

LS 00154 O
 Monocomando lavabo
 Single lever wash-basin mixer
 Mitigeur lavabo
 Einhand-Waschtischbatte
 Monomando lavabo

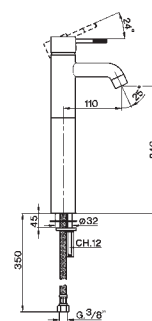

LS 00254 O
 Monocomando lavabo
 Single lever wash-basin mixer
 Mitigeur lavabo
 Einhand-Waschtischbatte
 Monomando lavabo

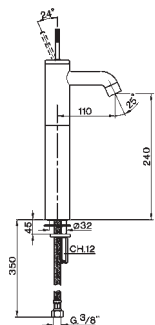

LS 00354 O
 Monocomando lavabo
 Single lever wash-basin mixer
 Mitigeur lavabo
 Einhand-Waschtischbatte
 Monomando lavabo

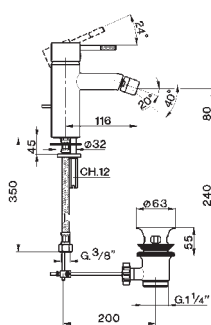

LS 00055 O
 Monocomando bidet
 Single lever bidet mixer
 Mitigeur bidet
 Einhand-Bidetbatte
 Monomando bidé

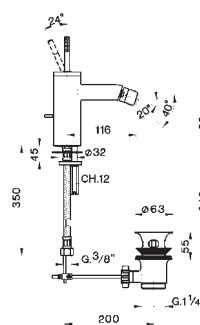

LS 00155 O
 Monocomando bidet
 Single lever bidet mixer
 Mitigeur bidet
 Einhand-Bidetbatte
 Monomando bidé

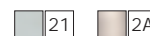

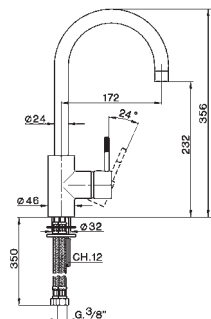

LS 0053 O

Monocomando lavello
Single lever sink mixer
Mitigreur évier
Nicht in Deutschland verfügbar
Monomando fregadero

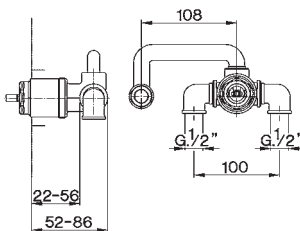

ZA 00651 O

Corpo monocomando lavabo incasso
Concealed single lever wash-basin mixer
Corps mitigreur lavabo encastré
Einhand-UP-Waschtischbatterie
Cuerpo monomando lavabo para empotrar

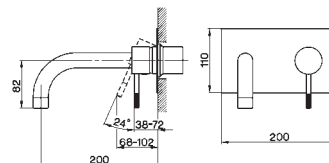

LS 00551 O

Parte esterna monocomando lavabo incasso
Visible parts for single lever wash-basin concealed mixer
Façade seule pour mitigreur lavabo encastré
UP-Einhand-Waschtischbatterie - Fertigmontageset
Parte exterior monomando lavabo para empotrar

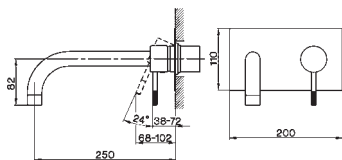
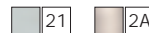

LS 00551 1

Parte esterna monocomando lavabo incasso
Visible parts for single lever wash-basin concealed mixer
Façade seule pour mitigreur lavabo encastré
UP-Einhand-Waschtischbatterie - Fertigmontageset
Parte exterior monomando lavabo para empotrar

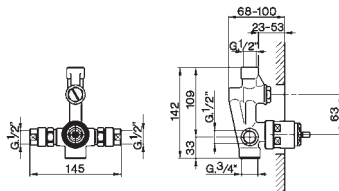

ZA 00421 O

Corpo monocomando vasca-doccia incasso
Concealed single lever bath-shower mixer
Corps seul mitigreur bain/douche encastré
Einhand-UP-Wannenfüll-u. Brausebatterie - Wandeinbausatz
Cuerpo monomando bañera/ducha para empotrar

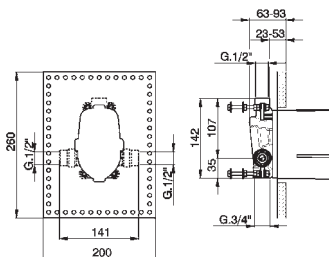

ZA 00421 3

Corpo monocomando vasca-doccia incasso
Concealed single lever bath-shower mixer
Corps seul mitigreur bain/douche encastré
Einhand-UP-Wannenfüll-u. Brausebatterie - Wandeinbausatz
Cuerpo monomando bañera ducha para empotrar

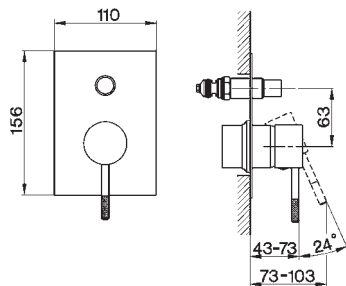

LS 00210 O

Parte esterna monocomando vasca-doccia incasso
 Visible parts for single lever bath-shower mixer
 Façade seule pour mitigeur bain/douche encastré
 Einhand-UP-Wannenfüll-u. Brausebatterie - Fertigmontageset
 Parte exterior monomando bañera-ducha para empotrar

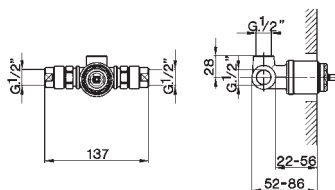

ZA 00431 O

Corpo monocomando doccia incasso
 Concealed single lever shower mixer
 Corps mitigeur douche encastré
 Einhand-UP-Brausebatterie - Wandeinbausatz
 Cuerpo monomando ducha para empotrar

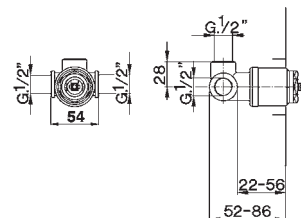

ZA 00431 1

Corpo monocomando doccia incasso
 Concealed single lever shower mixer
 Corps mitigeur douche encastré
 Einhand-UP-Brausebatterie - Wandeinbausatz
 Cuerpo monomando ducha para empotrar

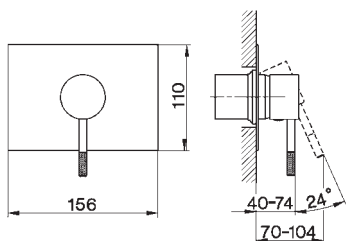

LS 00300 O

Parte esterna monocomando doccia incasso
 Visible parts for single lever shower mixer
 Façade seule pour mitigeur douche encastré
 UP-Brausebatterie - Fertigmontageset
 Parte exterior monomando ducha para empotrar

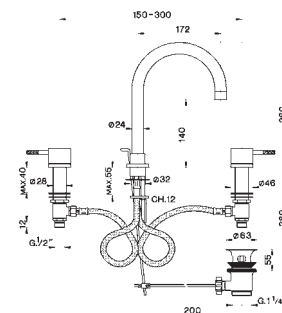

LS 00106 O

Batteria lavabo
 Wash basin mixer
 Mélangeur lavabo
 3 Loch-Waschtischbatterie
 Bateria lavabo

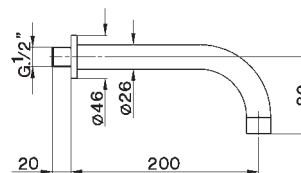

ZA 00125 O

Bocca di erogazione Ø 26
 Bath spout Ø 26
 Bec déverseur Ø 26
 Wanneneinlauf Ø 26
 Caño de erogación Ø 26



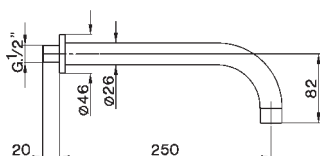

ZA 00125 1

Bocca di erogazione Ø 26
 Bath spout Ø 26
 Bec déverseur Ø 26
 Wanneneinlauf Ø 26
 Caño de erogación Ø 26

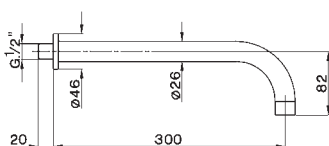

ZA 00125 2

Bocca di erogazione Ø 26
 Bath spout Ø 26
 Bec déverseur Ø 26
 Wanneneinlauf Ø 26
 Caño de erogación Ø 26

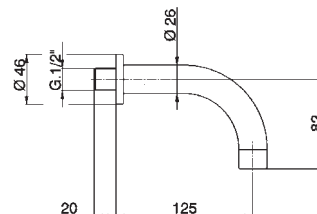

ZA 00125 3

Bocca di erogazione Ø 26
 Bath spout Ø 26
 Bec déverseur Ø 26
 Wanneneinlauf Ø 26
 Caño de erogación Ø 26

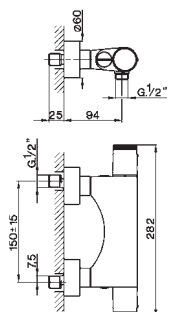
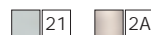

LS 00045 1

Miscelatore termostatico doccia esterno
 Thermostatic exposed shower mixer
 Mitigreur thermostatique de douche
 Aufputz-Thermostat Brausebatterie
 Mezclador termostático ducha exterior

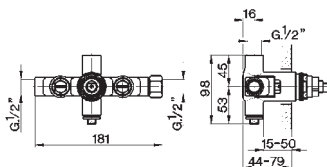

HY 00018 0

Corpo miscelatore termostatico incasso
 Thermostatic concealed mixer
 Partie encastrée pour mitigreur thermostatique
 UP-Thermostatbatterie
 Cuerpo mezclador termostático para empotrar

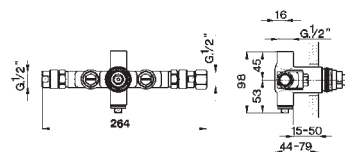

HY 00018 1

Corpo miscelatore termostatico incasso
 Thermostatic concealed mixer
 Partie encastrée pour mitigreur thermostatique
 UP-Thermostatbatterie
 Cuerpo mezclador termostático para empotrar

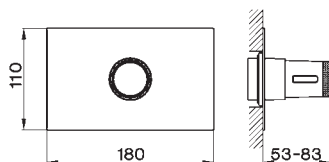

LS 00180 O

Parte esterna miscelatore
termostatico incasso
Visible parts for thermostatic
concealed mixer
Façade seule pour mitigeur
thermostatique encastré
UP-Thermostat Batterie
Parte exterior mezclador
termostático para empotrar

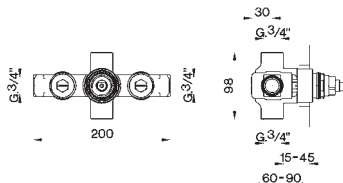

HY 00019 O

Corpo miscelatore termostatico incasso
Thermostatic concealed mixer
Partie encastrée pour mitigeur
thermostatique
UP-Thermostat Batterie
Cuerpo mezclador termostático para
empotrar

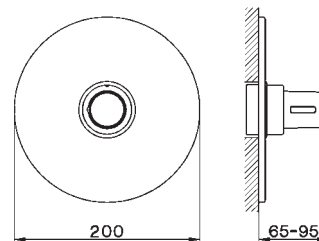

LS 00190 O

Parte esterna miscelatore
termostatico incasso
Visible parts for thermostatic
concealed mixer
Façade seule pour mitigeur
thermostatique encastré
UP-Thermostat Batterie
Parte exterior mezclador
termostático para empotrar

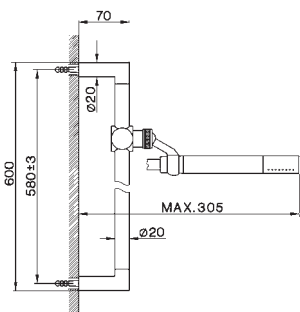
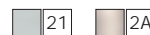

DS 01005 0

Set minimale
Minimal set
Combiné de douche minimal
Brauset set minimal
Juego minimal

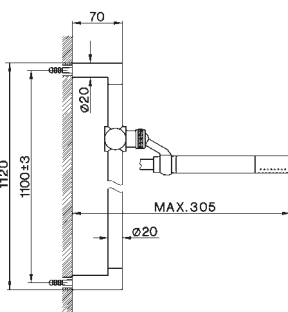

DS 01005 2

Set minimale
Minimal set
Combiné de douche minimal
Brauset set minimal
Juego minimal

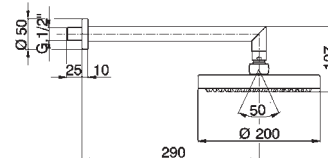

DS 01319 0

Braccio doccia
Shower arm
Bras de douche
Brauset arm
Brazo ducha



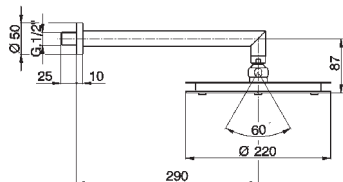

DS 01314 0

Braccio doccia Disco
Disco shower arm
Bras de douche Disco
Brausearm Disco
Brazo ducha Disco

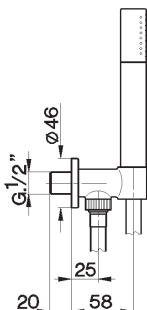

LS 00303 3

Supporto doccia incasso
Wall-mounted shower holder
Support mural
Wandhalter
Soporte ducha para empotrar

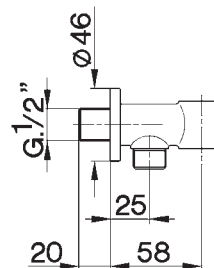

LS 00364 3

Supporto alimentazione a parete
Wall elbow
Raccord mural
Wandanschlussbogen
Soporte alimentación de pared

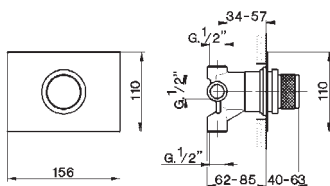
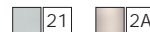

LS 00027 0

Deviatore a dischi ceramici 4 vie
4-way ceramic discs diverter
Inverseur à disques céramiques 4 voies
4-Wege-UP-Umstellung
Desviador de discos cerámicos 4 vías

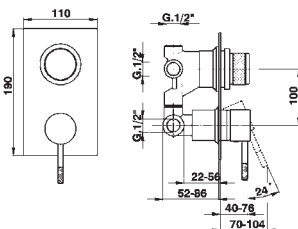

LS 00028 0

Deviatore a dischi ceramici 4 vie
4-way ceramic discs diverter
Inverseur à disques céramiques 4 voies
Badenbatteie UP-Umstellung
- 3 Ausgänge
Desviador de discos cerámicos 4 vías

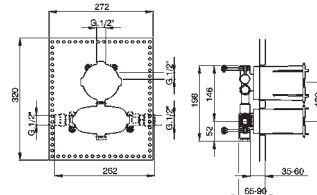

ZA 01840 0

Corpo incasso miscelatore
termostatico con deviatore a dischi
ceramici 3 vie
Thermostatic concealed mixer
with 3 ways ceramic discs diverter
Corps encastré mitigeur
thermostatique avec inverseur à
disques céramiques à 3 voies
UP Thermostatbatteie mit Umsteller
mit keramischen Scheiben 3 Wege
Cuerpo para empotrar mezclador
termostático con desviador de discos
cerámicos 3 vías



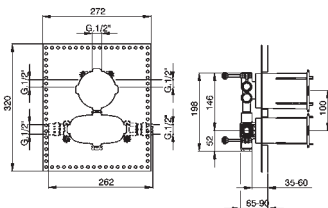

ZA 01850 0

Corpo incasso miscelatore
termostatico con deviatore a dischi
ceramici 4 vie
Thermostatic concealed mixer
with 4 ways ceramic discs diverter
Corps encastré mitigeur
thermostatique avec inverseur à
disques céramiques à 4 voies
UP Thermostatbatterie mit Umsteller
mit keramischen Scheiben 4 Wege
Cuerpo para empotrar mezclador
termostático con desviador de discos
cerámicos 4 vías

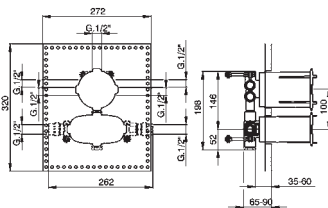

ZA 01860 0

Corpo incasso miscelatore
termostatico con deviatore a dischi
ceramici 6 vie
Thermostatic concealed mixer
with 6 ways ceramic discs diverter
Corps encastré mitigeur
thermostatique avec inverseur à
disques céramiques à 6 voies
UP Thermostatbatterie mit Umsteller
mit keramischen Scheiben 6 Wege
Cuerpo para empotrar mezclador
termostático con desviador de discos
cerámicos 6 vías

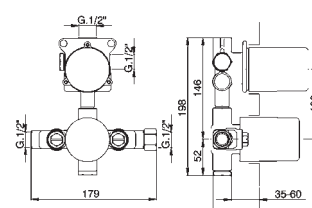

ZA 01840 1

Corpo incasso miscelatore
termostatico con deviatore a dischi
ceramici 3 vie
Thermostatic concealed mixer
with 3 ways ceramic discs diverter
Corps encastré mitigeur
thermostatique avec inverseur à
disques céramiques à 3 voies
UP Thermostatbatterie mit Umsteller
mit keramischen Scheiben 3 Wege
Cuerpo para empotrar mezclador
termostático con desviador de discos
cerámicos 3 vías

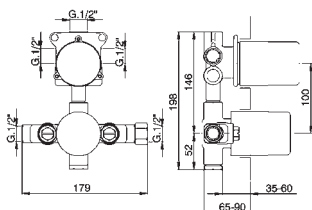

ZA 01850 1

Corpo incasso miscelatore
termostatico con deviatore a dischi
ceramici 4 vie
Thermostatic concealed mixer
with 4 ways ceramic discs diverter
Corps encastré mitigeur
thermostatique avec inverseur à
disques céramiques à 4 voies
UP Thermostatbatterie mit Umsteller
mit keramischen Scheiben 4 Wege
Cuerpo para empotrar mezclador
termostático con desviador de discos
cerámicos 4 vías

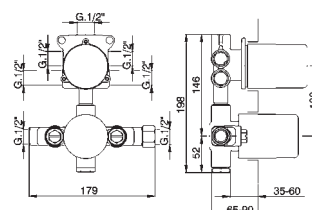

ZA 01860 1

Corpo incasso miscelatore
termostatico con deviatore a dischi
ceramici 6 vie
Thermostatic concealed mixer
with 6 ways ceramic discs diverter
Corps encastré mitigeur
thermostatique avec inverseur à
disques céramiques à 6 voies
UP Thermostatbatterie mit Umsteller
mit keramischen Scheiben 6 Wege
Cuerpo para empotrar mezclador
termostático con desviador de discos
cerámicos 6 vías

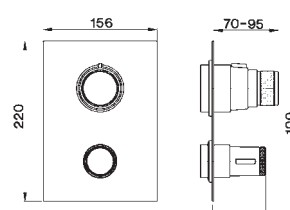

LS 01840 3

Miscelatore termostatico incasso con
deviatore a dischi ceramici 3 vie per
Art. ZA018400 e art. ZA018401
Thermostatic concealed mixer with 3
ways ceramic discs diverter for
Art. ZA018400 e art. ZA018401
Mitigeur thermostatique encastré avec
inverseur à disques céramiques 3 voies
pour art. ZA018400 e art. ZA018401
Thermostat Batterie mit 3 Wegen UP
Umstellung für Art. ZA018400 und
art. ZA018401
Mezclador termostático para empotrar
con desviador discos cerámicos 3 vías
para art. ZA018400 e art. ZA018401

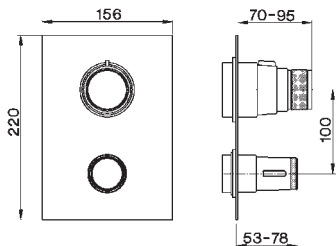

LS 01850 3

Miscelatore termostatico incasso con deviatore a dischi ceramici 4 vie per Art. ZA018500 e art. ZA018501
 Thermostatic concealed mixer with 4 ways ceramic discs diverter for Art. ZA018500 e art. ZA018501
 Mitigeur thermostatique encastré avec inverseur à disques céramiques 4 voies pour art. ZA018500 e art. ZA018501
 Thermostat Batterie mit 4 Wegen UP Umstellung für Art. ZA018500 und art. ZA018501
 Mezclador termostático para empotrar con desviador discos cerámicos 4 vías para art. ZA018500 e art. ZA018501

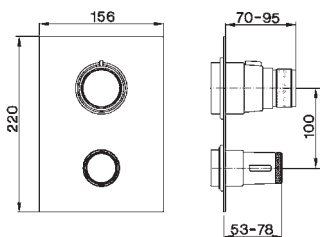

LS 01860 3

Miscelatore termostatico incasso con deviatore a dischi ceramici 6 vie per Art. ZA018600 e art. ZA018601
 Thermostatic concealed mixer with 6 ways ceramic discs diverter for Art. ZA018600 e art. ZA018601
 Mitigeur thermostatique encastré avec inverseur à disques céramiques 6 voies pour art. ZA018600 e art. ZA018601
 Thermostat Batterie mit 6 Wegen UP Umstellung für Art. ZA018600 und art. ZA018601
 Mezclador termostático para empotrar con desviador discos cerámicos 6 vías para art. ZA018600 e art. ZA018601

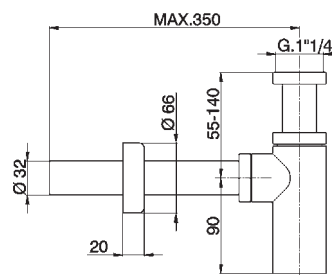

ZA 00404 2

Sifone minimale
 Siphon minimal
 Siphon minimal
 Siphon Minimal

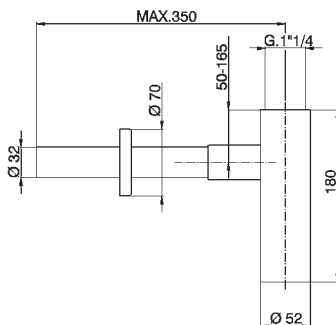
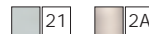

ZA 00407 0

Sifone
 Siphon
 Siphon
 Siphon
 Sifón

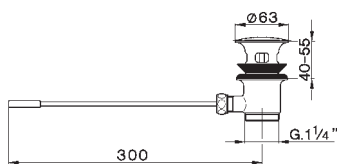

ZA 00580 0

Scarico automatico
 Automatic pop-up waste
 Vidage automatique
 Automatische Ablaufgarnitur
 Desagüe automático

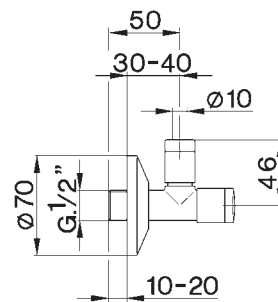

ZA 00290 0

Rubinetto d'alimentazione
 Angle supply
 Robinet d'alimentation
 Eckventil 1/2"
 Grifo de alimentación





LS 01000 0

Terminale leva monocomando Less
 Less lever knob
 Embout levier Less
 Design Griffelement Less
 Terminal palanca monomando Less

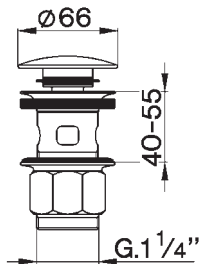

ZA 00162 0

Piletta Rapid 1"1/4 per lavabo
 Waste Rapid 1"1/4 for basin
 Crépine Rapid 1"1/4 pour lavabo
 Ablauf Rapid 1"1/4 für Waschtisch
 Válvula Rapid 1"1/4 para lavabo

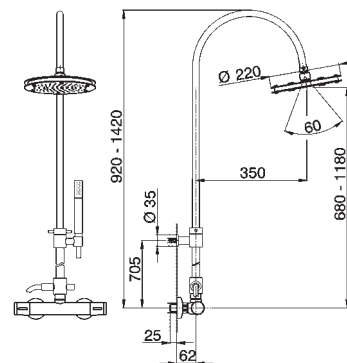

LS 00408 0

Termostatico doccia esterno con doccia alta
 Thermostatic exposed shower mixer with high shower
 Thermostatique douche mural avec colonne de douche
 AP Brausethermostatbatterie mit hoehrer Brause
 Termostático ducha exterior con ducha alta



LESS MINIMAL

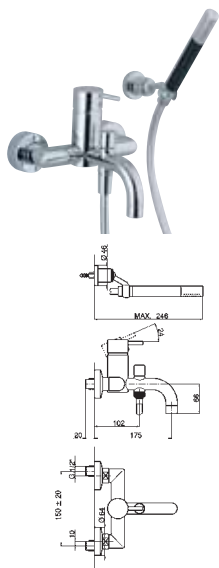

LM 00012 0
 Monocomando vasca
 Single lever bath mixer
 Mitigeur bain/douche
 Einhand-Badebatte
 Monomando bañera

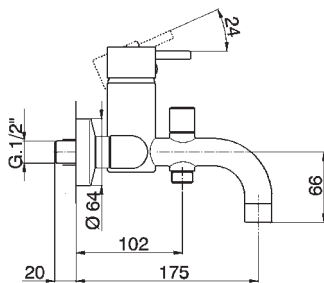

LM 00015 0
 Monocomando vasca
 Single lever bath mixer
 Mitigeur bain/douche
 Einhand-Badebatte
 Monomando bañera

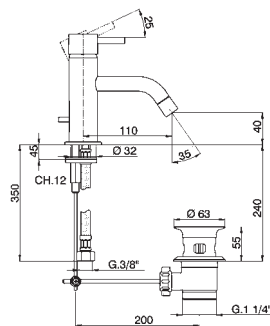

LM 00051 0
 Monocomando lavabo
 Single lever wash-basin mixer
 Mitigeur lavabo
 Einhand-Waschtischbatte
 Monomando lavabo

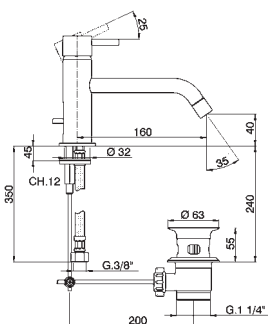
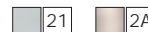

LM 00151 0
 Monocomando lavabo
 Single lever wash-basin mixer
 Mitigeur lavabo
 Einhand-Waschtischbatte
 Monomando lavabo

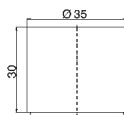

ZA 00610 0
 Prolunga per monocomando
 Extension for single lever mixer
 Rallonge pour mitigeur
 Verlängerungsset fuer Einhand
 Alargadera para monomando

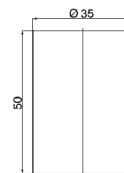

ZA 00610 1
 Prolunga per monocomando
 Extension for single lever mixer
 Rallonge pour mitigeur
 Verlängerungsset fuer Einhand
 Alargadera para monomando



LESS MINIMAL



ZA 00610 2

Prolunga per monocomando
 Extension for single lever mixer
 Rallonge pour mitigeur
 Verlängerungsset fuer Einhand
 Alargadera para monomando

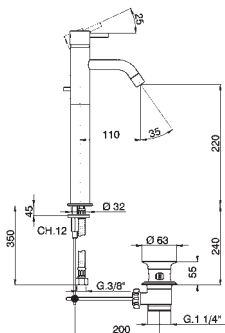

LM 00052 0

Monocomando lavabo
 Single lever wash-basin mixer
 Mitigeur lavabo
 Einhand-Waschtischbatte
 Monomando lavabo

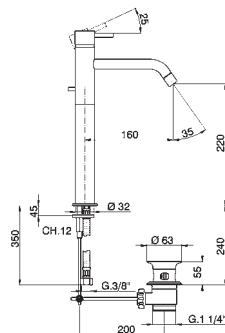

LM 00152 0

Monocomando lavabo
 Single lever wash-basin mixer
 Mitigeur lavabo
 Einhand-Waschtischbatte
 Monomando lavabo

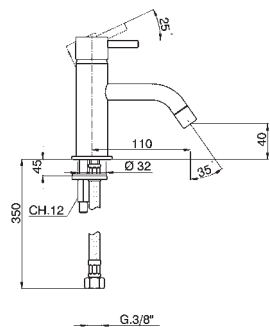
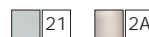

LM 00054 0

Monocomando lavabo
 Single lever wash-basin mixer
 Mitigeur lavabo
 Einhand-Waschtischbatte
 Monomando lavabo

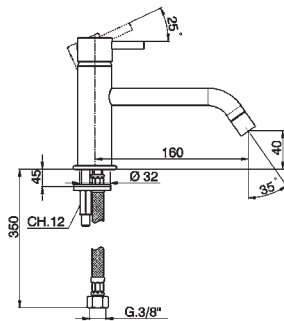

LM 00154 0

Monocomando lavabo
 Single lever wash-basin mixer
 Mitigeur lavabo
 Einhand-Waschtischbatte
 Monomando lavabo

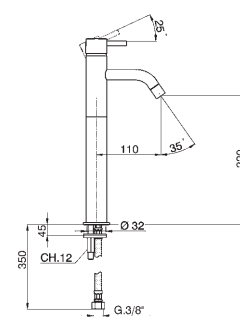

LM 00254 0

Monocomando lavabo
 Single lever wash-basin mixer
 Mitigeur lavabo
 Einhand-Waschtischbatte
 Monomando lavabo



LESS MINIMAL

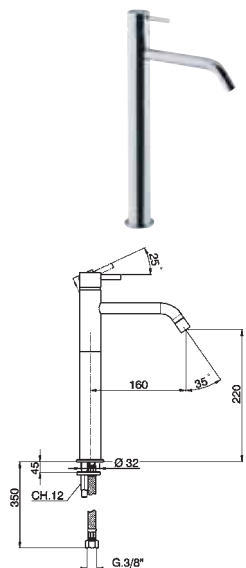

LM 00354 0
 Monocomando lavabo
 Single lever wash-basin mixer
 Mitigeur lavabo
 Einhand-Waschtischbatterie
 Monomando lavabo

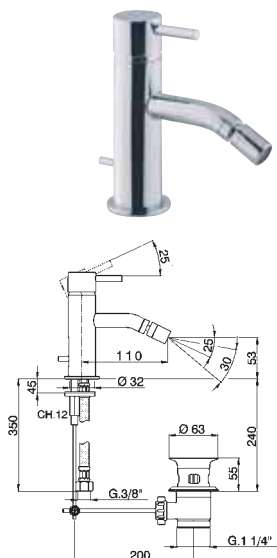

LM 00055 0
 Monocomando bidet
 Single lever bidet mixer
 Mitigeur bidet
 Einhand-Bidetbatterie
 Monomando bidé

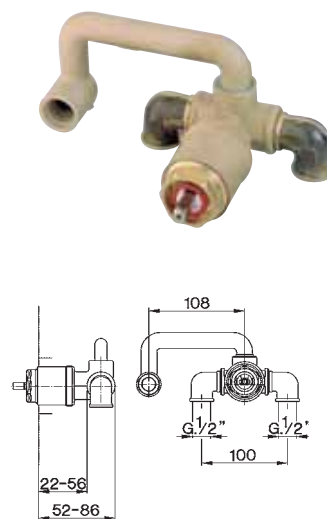

ZA 00651 0
 Corpo monocomando lavabo incasso
 Concealed single lever wash-basin mixer
 Corps mitigeur lavabo encastré
 Einhand-UP-Waschtischbatterie
 Cuerpo monomando lavabo para empotrar

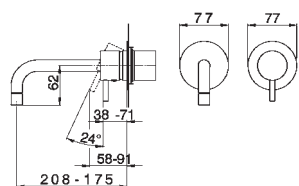

LM 00551 0
 Parte esterna monocomando lavabo incasso
 Visible parts for single lever wash-basin concealed mixer
 Façade seule pour mitigeur lavabo encastré
 UP-Einhand-Waschtischbatterie - Fertigmontageset
 Parte exterior monomando lavabo para empotrar

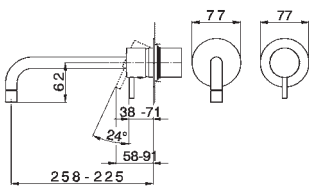

LM 00551 1
 Parte esterna monocomando lavabo incasso
 Visible parts for single lever wash-basin concealed mixer
 Façade seule pour mitigeur lavabo encastré
 UP-Einhand-Waschtischbatterie - Fertigmontageset
 Parte exterior monomando lavabo para empotrar

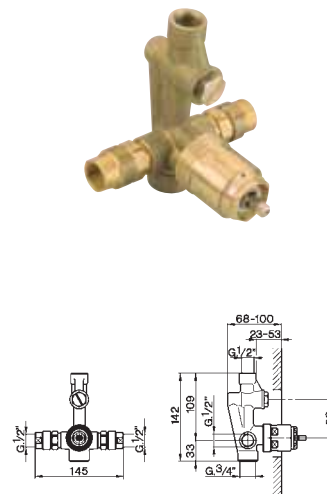

ZA 00421 0
 Corpo monocomando vasca-doccia incasso
 Concealed single lever bath-shower mixer
 Corps seul mitigeur bain/douche encastré
 Einhand-UP-Wannenfüll-u. Brausebatterie - Wandeinbausatz
 Cuerpo monomando bañera/ducha para empotrar

LESS MINIMAL

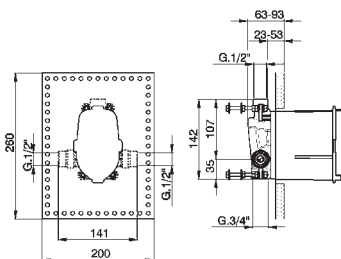

ZA 00421 3

Corpo monocomando vasca-doccia incasso
 Concealed single lever bath-shower mixer
 Corps seul mitigeur bain/douche encastré
 Einhand-UP-Wannenfüll-u. Brausebatterie - Wandeinbausatz
 Cuerpo monomando bañera/ducha para empotrar

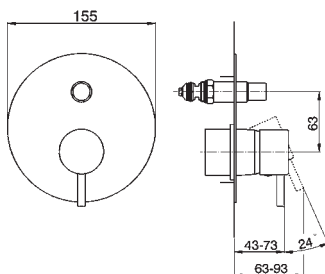

LM 00210 0

Parte esterna monocomando vasca-doccia incasso
 Visible parts for single lever bath-shower mixer
 Façade seule pour mitigeur bain/douche encastré
 Einhand-UP-Wannenfüll-u. Brausebatterie - Fertigmontageset
 Parte exterior monomando bañera-ducha para empotrar

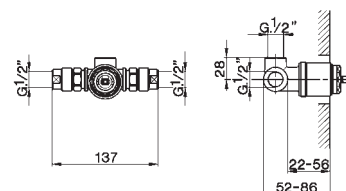

ZA 00431 0

Corpo monocomando doccia incasso
 Concealed single lever shower mixer
 Corps mitigeur douche encastré
 Einhand-UP-Brausebatterie - Wandeinbausatz
 Cuerpo monomando ducha para empotrar

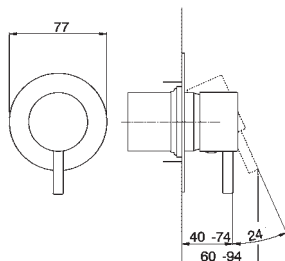

LM 00300 0

Parte esterna monocomando doccia incasso
 Visible parts for single lever shower mixer
 Façade seule pour mitigeur douche encastré
 UP-Brausebatterie - Fertigmontageset
 Parte exterior monomando ducha para empotrar

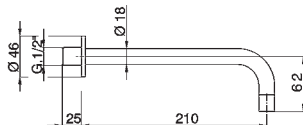

ZA 00225 0

Bocca di erogazione Ø 18
 Bath spout Ø 18
 Bec déverseur Ø 18
 Wanneneinlauf Ø 18
 Caño de erogación Ø 18

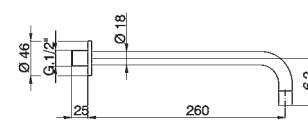

ZA 00225 1

Bocca di erogazione Ø 18
 Bath spout Ø 18
 Bec déverseur Ø 18
 Wanneneinlauf Ø 18
 Caño de erogación Ø 18



LESS MINIMAL

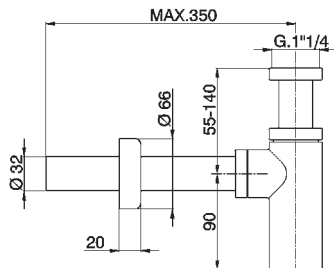

ZA 00404 2

Sifone minimale
Siphon minimal
Siphon minimal
Siphon minimale
Sifón Minimal

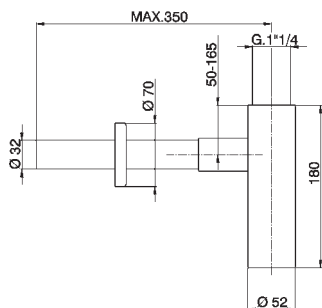

ZA 00407 0

Sifone
Siphon
Siphon
Siphon
Siphon
Sifón

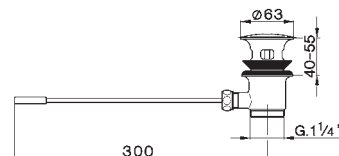

ZA 00580 0

Scarico automatico
Automatic pop-up waste
Vidage automatique
Automatische Ablaufgarnitur
Desagüe automático

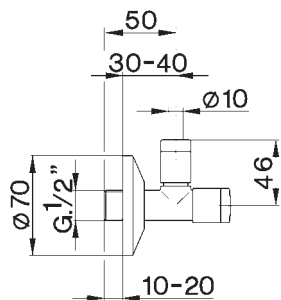

ZA 00290 0

Rubinetto d'alimentazione
Angle supply
Robinet d'alimentation
Eckventil
Grifo de alimentación

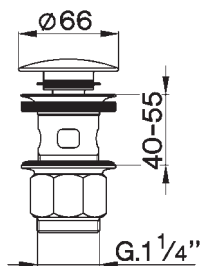

ZA 00162 0

Piletta Rapid 1" 1/4 per lavabo
Waste Rapid 1" 1/4 for basin
Crépine Rapid 1" 1/4 pour lavabo
Ablauf Rapid 1" 1/4 für Waschtisch
Válvula Rapid 1" 1/4 para lavabo



BARCELONA QUAD

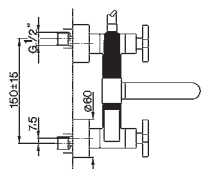
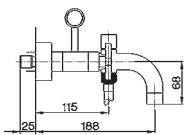

BQ 00010 0

Gruppo vasca
Bath mixer
Mélangeur bain/douche
Badebatterie
Grupo bañera

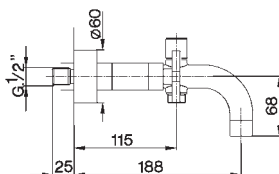

BQ 00013 0

Gruppo vasca
Bath mixer
Mélangeur bain/douche
Badebatterie
Grupo bañera

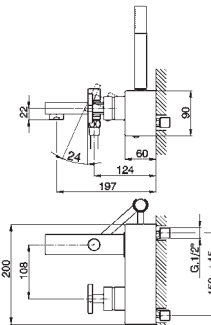

BQ 00014 0

Monocomando vasca
Single lever bath mixer
Mitigeur bain/douche
Einhand-Badebatterie
Monomando bañera

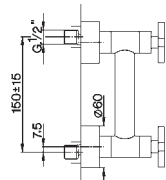
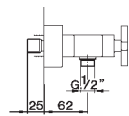
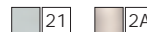

BQ 00044 1

Gruppo doccia esterno
Wall mounted shower mixer
Mélangeur douche
Brause Wandbatterie
Grupo ducha exterior

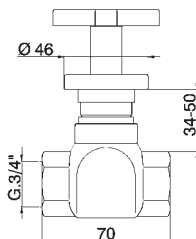

BQ 00030 3

Rubinetto incasso
Concealed valve
Robinet à encastrer
Einhand Waschtischbatterie
Grifo para empotrar

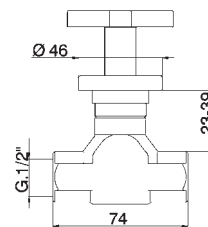

BQ 00031 0

Rubinetto incasso
Concealed valve
Robinet à encastrer
Einhand Waschtischbatterie
Grifo para empotrar

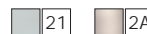

BARCELONA QUAD

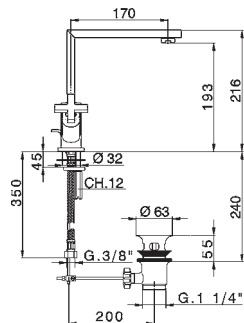

BQ 00052 0

Monoforo lavabo
Single hole basin mixer
Mélangeur monotrou lavabo
Einloch-Waschtischbatteie
Monobloc lavabo

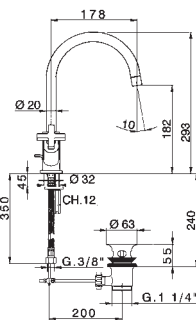

BQ 00152 0

Monoforo lavabo
Single hole basin mixer
Mélangeur monotrou lavabo
Einloch-Waschtischbatteie
Monobloc lavabo

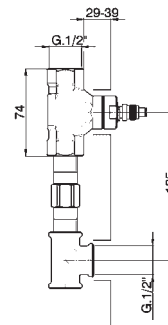

ZA 01351 0

Parte incasso gruppo lavabo incasso
Concealed wash basin mixer
Corps seul mélangeur lavabo encastré
UP-Waschtischbatteie Wandeinbausatz
Parte interna grupo lavabo para empotrar

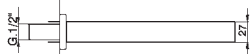
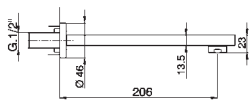

BQ 01351 0

Parte esterna gruppo lavabo incasso
Visible parts concealed wash basin mixer
Façade seule pour mélangeur lavabo encastré
UP-Waschtischbatteie
Fertigmontageset
Parte exterior grupo lavabo para empotrar

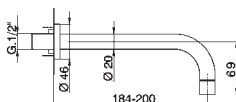

BQ 01751 0

Parte esterna gruppo lavabo incasso
Visible parts concealed wash basin mixer
Façade seule pour mélangeur lavabo encastré
UP-Waschtischbatteie
Fertigmontageset
Parte exterior grupo lavabo para empotrar

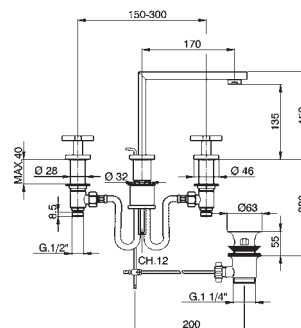
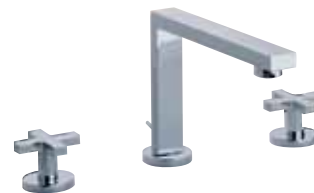

BQ 00106 0

Batteria lavabo
Wash basin mixer
Mélangeur lavabo
Waschtischbatteie
Bateria lavabo



BARCELONA QUAD

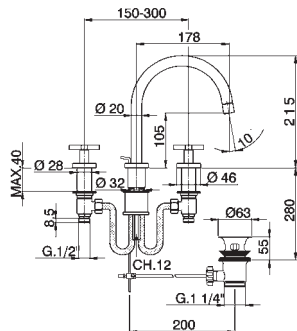

BQ 00107 0

Batteria lavabo
Wash basin mixer
Mélangeur lavabo
Waschtischbatterie
Bateria lavabo

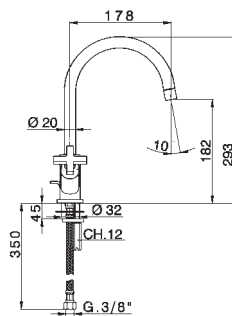

BQ 00053 1

Monoforo lavello
Single hole sink mixer
Mélangeur monotrou évier
Einloch-Spültischbatterie
Monobloc fregadero

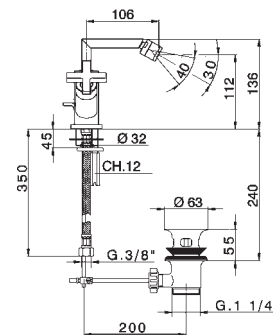

BQ 00055 0

Monoforo bidet
Single hole bidet mixer
Mélangeur monotrou bidet
Einloch-Bidetbatterie
Monobloc bidé

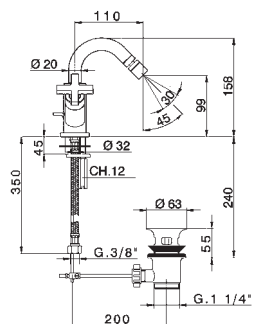
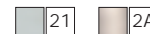

BQ 00155 0

Monoforo bidet
Single hole bidet mixer
Mélangeur monotrou bidet
Einloch-Bidetbatterie
Monobloc bidé



BARCELONA QUAD

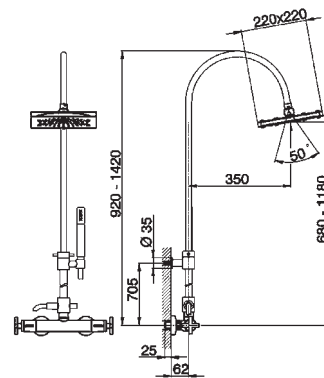
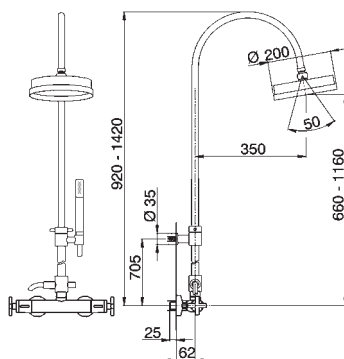
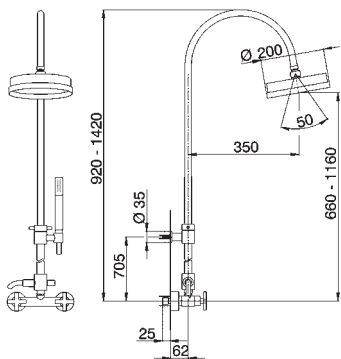

BQ 00405 1

Gruppo doccia esterno
Wall-mounted shower mixer
Mélangeur douche
Brause-Wandbatterie
Grupo ducha exterior

BQ 00408 0

Termostatico doccia esterno con doccia alta
Thermostatic exposed shower mixer with high shower
Thermostatique douche mural avec colonne de douche
AP Brausethermostatbatterie mit hoeher Brause
Termostático ducha exterior con ducha alta

BQ 00408 1

Termostatico doccia esterno con doccia alta
Thermostatic exposed shower mixer with high shower
Thermostatique douche mural avec colonne de douche
AP Brausethermostatbatterie mit hoeher Brause
Termostático ducha exterior con ducha alta

BARCELONA QUAD

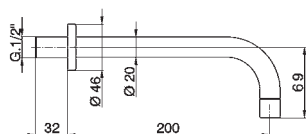

ZA 00325 0

Bocca di erogazione Ø20
Bath spout Ø20
Bec déverseur Ø20
Wanneneinlauf Ø20
Caño de erogación Ø20

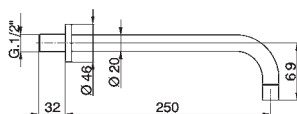

ZA 00325 1

Bocca di erogazione Ø20
Bath spout Ø20
Bec déverseur Ø20
Wanneneinlauf Ø20
Caño de erogación Ø20



ZA 00219 0

Bocca di erogazione
Bath spout
Bec déverseur
Wanneneinlauf
Caño de erogación

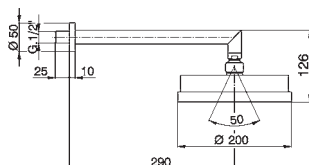

DS 01316 0

Braccio doccia
Shower arm
Bras de douche
Brausearm

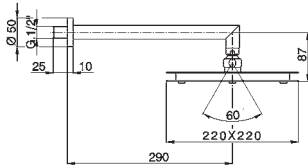

DS 01317 0

Braccio doccia Quad
Quad shower arm
Bras de douche Quad
Brausearm Quad
Brazo ducha Quad

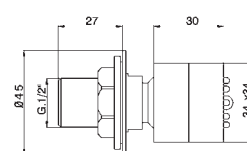

DS 01507 0

Soffione laterale Quad
Quad side shower
Pommes de douche laterale Quad
Seifenbrause Quad
Rociador lateral Quad



BARCELONA QUAD

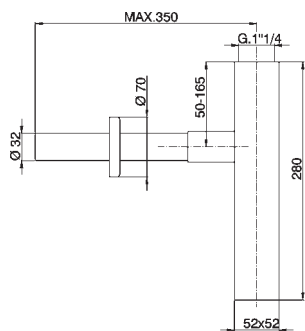

ZA 00408 0

Sifone Quad
Quad siphon
Siphon Quad
Roehrensiphon Quad
Sifón Quad

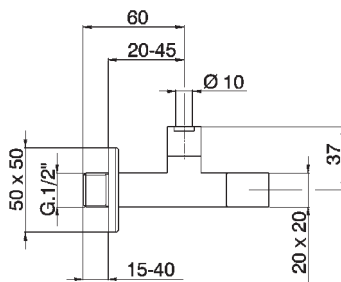

ZA 00291 0

Rubinetto d'alimentazione
Robinet d'alimentation
Angle supply
Eckventil
Grifo de alimentación



BARCELONA

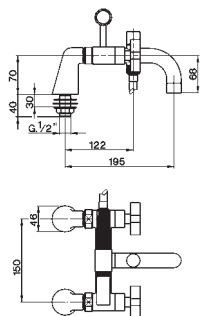

BA 0009 0

Gruppo vasca a squadra
Deck mounted bath mixer
Mélangeur bain/douche sur gorge
Badebatterie
Grupo bañera de escuadra

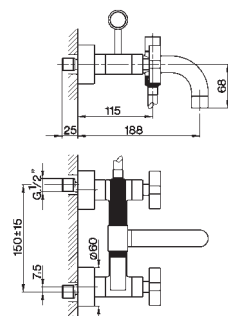

BA 0010 0

Gruppo vasca
Bath mixer
Mélangeur bain/douche
Badebatterie
Grupo bañera

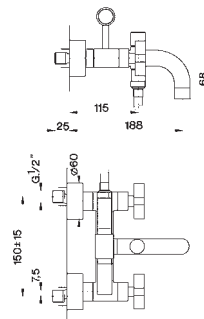

BA 0010 3

Gruppo vasca
Bath mixer
Mélangeur bain/douche
Badebatterie
Grupo bañera

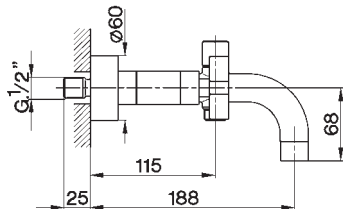
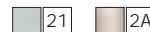

BA 0013 0

Gruppo vasca
Bath mixer
Mélangeur bain/douche
Badebatterie
Grupo bañera

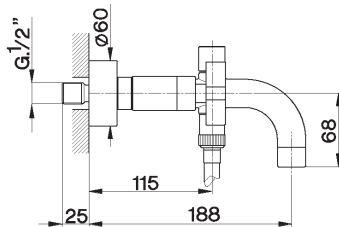

BA 0013 3

Gruppo vasca
Bath mixer
Mélangeur bain/douche
Badebatterie
Grupo bañera

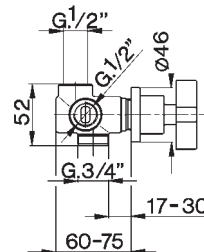

BA 0020 0

Deviatore incasso a 4 vie
Concealed diverter 4 way
Inverseur à encastrer 4 voies
4-Wege-UP-Umstellung
Desviador para empotrar de 4 vías

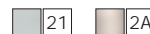

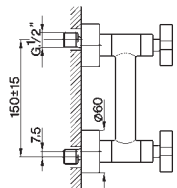
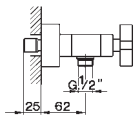

BA 00044 1

Gruppo doccia esterno
Wall-mounted shower mixer
Mélangeur douche
Brause-Wandbatterie
Grupo ducha exterior

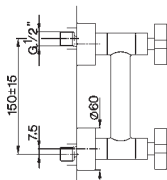
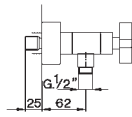

BA 00044 3

Gruppo doccia esterno
Wall-mounted shower mixer
Mélangeur douche
Brause-Wandbatterie
Grupo ducha exterior

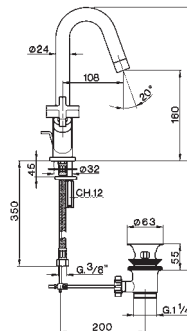

BA 00051 0

Monoforo lavabo
Single hole basin mixer
Mélangeur monotrou lavabo
Einloch-Waschtischbatterie
Monobloc lavabo

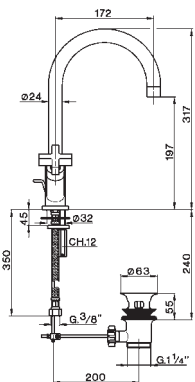
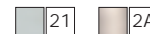

BA 00052 0

Monoforo lavabo
Single hole basin mixer
Mélangeur monotrou lavabo
Einloch-Waschtischbatterie
Monobloc lavabo

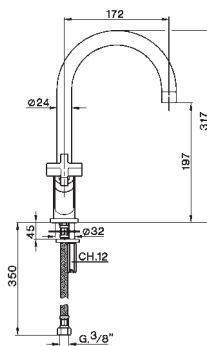

BA 00053 0

Monoforo lavello
Single hole sink mixer
Mélangeur monotrou évier
Einloch-Spültischbatterie
Monobloc fregadero

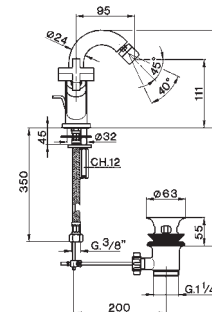

BA 00055 0

Monoforo bidet
Single hole bidet mixer
Mélangeur monotrou bidet
Einloch Bidetbatterie
Monobloc bidé

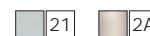

BARCELONA

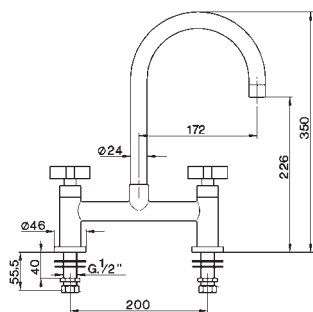

BA 00072 0

Gruppo universale verticale
Deck-mounted basin mixer
Mélangeur évier sur gorge
Nicht in Deutschland verfügbar
Grupo fregadero de puente

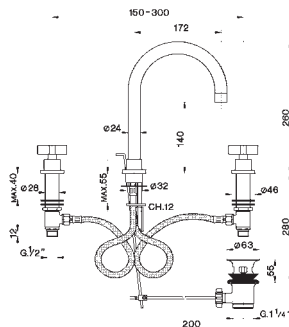

BA 00106 0

Batteria lavabo
Wash basin mixer
Mélangeur lavabo
Waschtischbatterie
Bateria lavabo

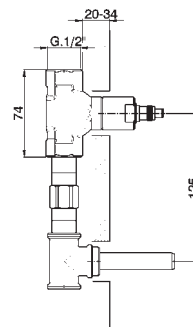

ZA 00351 0

Parte incasso gruppo lavabo incasso
Concealed wash basin mixer
Corps seul mélangeur lavabo encastré
UP-Waschtischbatterie Wandeinbausatz
Parte interna grupo lavabo para empotrar

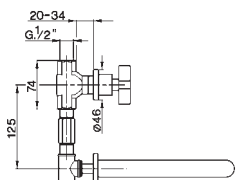
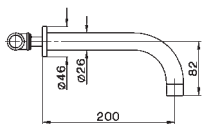

BA 01351 0

Parte esterna gruppo lavabo incasso
Visible parts concealed wash basin mixer
Façade seule pour mélangeur lavabo encastré
UP-Waschtischbatterie
Fertigmontageset
Parte exterior grupo lavabo para empotrar

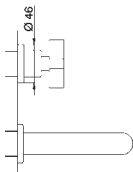
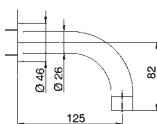

BA 01351 1

Parte esterna gruppo lavabo incasso
Visible parts concealed wash basin mixer
Façade seule pour mélangeur lavabo encastré
UP-Waschtischbatterie
Fertigmontageset
Parte exterior grupo lavabo para empotrar

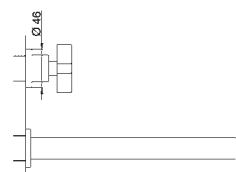
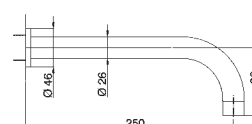

BA 01351 2

Parte esterna gruppo lavabo incasso
Visible parts concealed wash basin mixer
Façade seule pour mélangeur lavabo encastré
UP-Waschtischbatterie
Fertigmontageset
Parte exterior grupo lavabo para empotrar

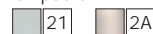

BARCELONA

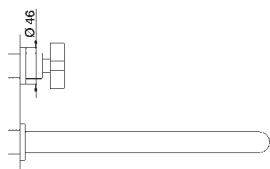
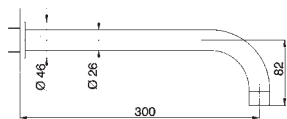

BA 01351 3

Parte esterna gruppo lavabo incasso
Visible parts concealed wash basin mixer
Façade seule pour mélangeur lavabo
encastré
UP-Waschtischbatterie
Fertigmontageset
Parte exterior grupo lavabo para
empotrar

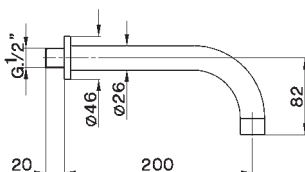

ZA 00125 0

Bocca di erogazione
Bath spout
Bec déverseur
Wanneneinlauf
Caño de erogación

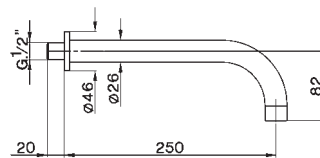

ZA 00125 1

Bocca di erogazione
Bath spout
Bec déverseur
Wanneneinlauf
Caño de erogación

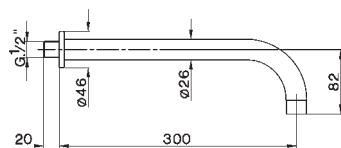
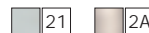

ZA 00125 2

Bocca di erogazione
Bath spout
Bec déverseur
Wanneneinlauf
Caño de erogación

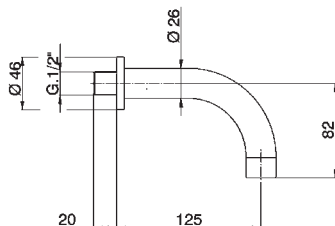

ZA 00125 3

Bocca di erogazione
Bath spout
Bec déverseur
Wanneneinlauf
Caño de erogación

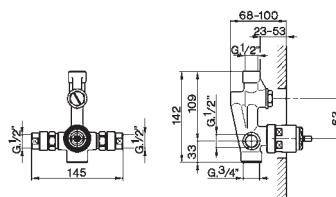

ZA 00421 0

Corpo monocomando vasca-doccia
incasso
Concealed single lever bath-shower
mixer
Corps seul mitigeur bain/douche
encastré
Einhand-UP-Wannenfüll-u.
Brausebatterie - Wandeinbausatz
Cuerpo monomando bañera/ducha para
empotrar

BARCELONA

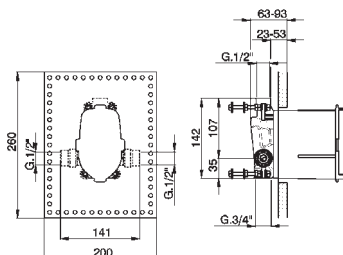

ZA 00421 3

Corpo monocomando vasca-doccia incasso
 Concealed single lever bath-shower mixer
 Corps seul mitigeur bain/douche encastré
 Einhand-UP-Wannenfüll-u. Brausebatterie - Wandeinbausatz
 Cuerpo monomando bañera/ducha para empotrar

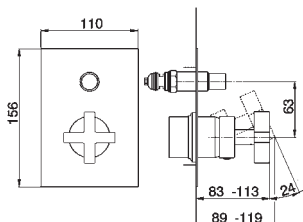

BA 00210 0

Parte esterna monocomando vasca-doccia incasso
 Visible parts for single lever bath-shower mixer
 Façade seule pour mitigeur bain/douche encastré
 Einhand-UP-Wannenfüll-u. Brausebatterie - Fertigmontageseta
 Parte exterior monomando bañera-ducha para empotrar

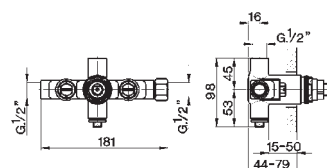

HY 00018 0

Corpo miscelatore termostatico incasso
 Thermostatic concealed mixer
 Partie encastrée pour mitigeur thermostatique
 UP-Thermostatbatterie
 Cuerpo mezclador termostático para empotrar

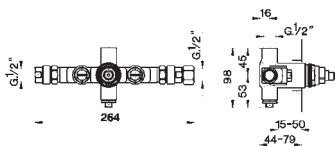

HY 00018 1

Corpo miscelatore termostatico incasso
 Thermostatic concealed mixer
 Partie encastrée pour mitigeur thermostatique
 UP-Thermostatbatterie
 Cuerpo mezclador termostático para empotrar

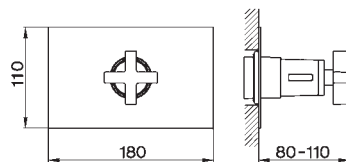

BA 00180 0

Parte esterna miscelatore termostatico incasso
 Visible parts for thermostatic concealed mixer
 Façade seule pour mitigeur thermostatique encastré
 UP-Thermostat Batterie
 Parte exterior mezclador termostático ducha para empotrar

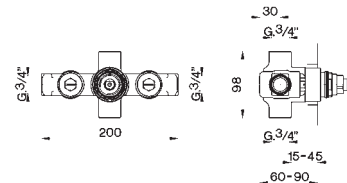

HY 00019 0

Corpo miscelatore termostatico incasso
 Thermostatic concealed mixer
 Partie encastrée pour mitigeur thermostatique
 UP-Thermostatbatterie
 Cuerpo mezclador termostático para empotrar

BARCELONA

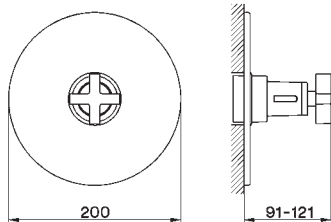

BA 00190 0

Parte esterna miscelatore
termostatico incasso
Visible parts for thermostatic
concealed mixer
Façade seule pour mitigeur
thermostatique encastré
UP-Thermostat Batterie
Parte exterior mezclador
termostático para empotrar

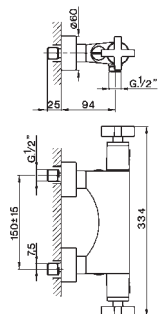

BA 00045 1

Miscelatore termostatico doccia
esterno
Thermostatic exposed shower mixer
Mitigeur thermostatique de douche
Aufputz-Thermostat Brausebatterie
Termostático ducha exterior

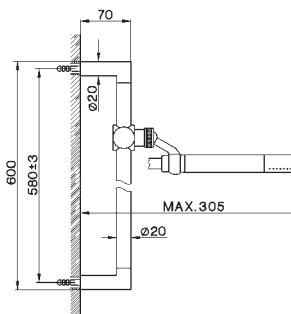

DS 01005 0

Set minimale
Minimal set
Combiné de douche minimal
Brauseset minimal
Juego minimal

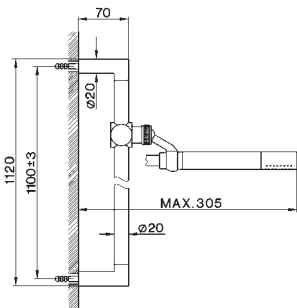

DS 01005 2

Set minimale
Minimal set
Combiné de douche minimal
Brauseset minimal
Juego minimal

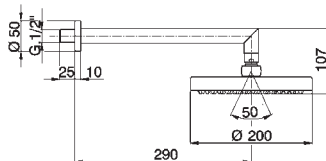

DS 01319 0

Braccio doccia
Shower arm
Bras de douche
Brausearm
Brazo ducha

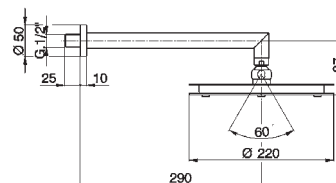

DS 01314 0

Braccio doccia Disco
Disco shower arm
Bras de douche Disco
Brausearm Disco
Brazo ducha Disco

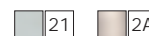

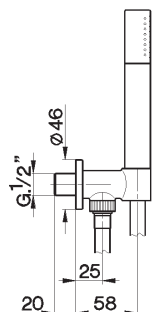

LS 00303 3

Supporto doccia incasso
Wall-mounted shower holder
Support mural
Wandhalter
Soporte ducha para empotrar

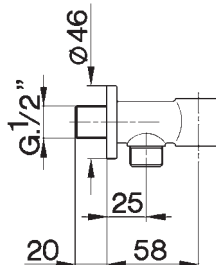

LS 00364 3

Supporto alimentazione a parete
Wall elbow
Raccord mural
Wandanschlussbogen
Soporte alimentación de pared

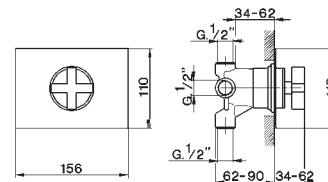

BA 00027 0

Deviatore a dischi ceramici 4 vie
4-way ceramic discs diverter
Inverseur à disques céramiques 4 voies
4-Wege-UP-Umstellung
Desviador de discos cerámicos 4 vías

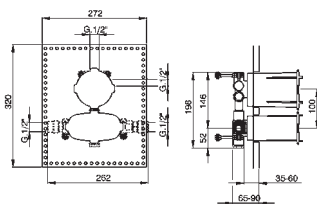
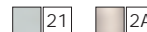

ZA 01840 0

Corpo incasso miscelatore
termostatico con deviatore a dischi
ceramici 3 vie
Thermostatic concealed mixer
with 3 ways ceramic discs diverter
Corps encastré mitigeur
thermostatique avec inverseur à
disques céramiques à 3 voies
UP Thermostatbatterie mit Umsteller
mit keramischen Scheiben 3 Wege
Cuerpo para empotrar mezclador
termostático con desviador de discos
cerámicos 3 vías

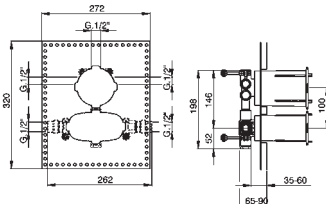

ZA 01850 0

Corpo incasso miscelatore
termostatico con deviatore a dischi
ceramici 4 vie
Thermostatic concealed mixer
with 4 ways ceramic discs diverter
Corps encastré mitigeur
thermostatique avec inverseur à
disques céramiques à 4 voies
UP Thermostatbatterie mit Umsteller
mit keramischen Scheiben 4 Wege
Cuerpo para empotrar mezclador
termostático con desviador de discos
cerámicos 4 vías

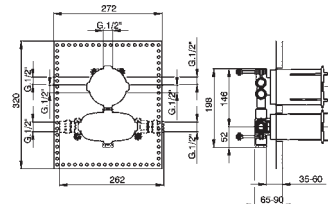

ZA 01860 0

Corpo incasso miscelatore
termostatico con deviatore a dischi
ceramici 6 vie
Thermostatic concealed mixer
with 6 ways ceramic discs diverter
Corps encastré mitigeur
thermostatique avec inverseur à
disques céramiques à 6 voies
UP Thermostatbatterie mit Umsteller
mit keramischen Scheiben 6 Wege
Cuerpo para empotrar mezclador
termostático con desviador de discos
cerámicos 6 vías

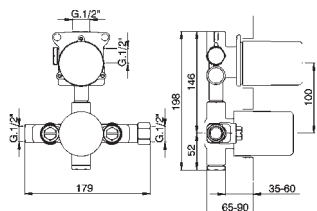

ZA 01840 1

Corpo incasso miscelatore termostatico con deviatore a dischi ceramici 3 vie
 Thermostatic concealed mixer with 3 ways ceramic discs diverter
 Corps encastré mitigeur thermostatique avec inverseur à disques céramiques à 3 voies
 UP Thermostatbatterie mit Umsteller mit keramischen Scheiben 3 Wege
 Cuerpo para empotrar mezclador termostático con desviador de discos cerámicos 3 vías

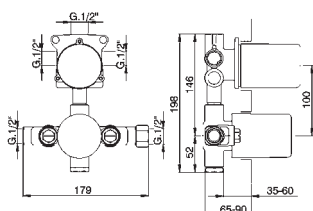

ZA 01850 1

Corpo incasso miscelatore termostatico con deviatore a dischi ceramici 4 vie
 Thermostatic concealed mixer with 4 ways ceramic discs diverter
 Corps encastré mitigeur thermostatique avec inverseur à disques céramiques à 4 voies
 UP Thermostatbatterie mit Umsteller mit keramischen Scheiben 4 Wege
 Cuerpo para empotrar mezclador termostático con desviador de discos cerámicos 4 vías

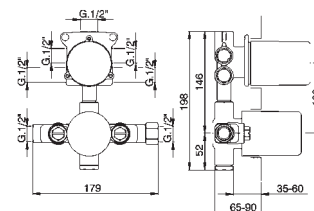

ZA 01860 1

Corpo incasso miscelatore termostatico con deviatore a dischi ceramici 6 vie
 Thermostatic concealed mixer with 6 ways ceramic discs diverter
 Corps encastré mitigeur thermostatique avec inverseur à disques céramiques à 6 voies
 UP Thermostatbatterie mit Umsteller mit keramischen Scheiben 6 Wege
 Cuerpo para empotrar mezclador termostático con desviador de discos cerámicos 6 vías

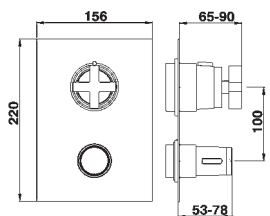

BA 01840 3

Miscelatore termostatico incasso con deviatore a dischi ceramici 3 vie per Art. ZA018400 e art. ZA018401
 Thermostatic concealed mixer with 3 ways ceramic discs diverter for Art. ZA018400 e art. ZA018401
 Mitigeur thermostatique encastré avec inverseur à disques céramiques 3 voies pour art. ZA018400 e art. ZA018401
 Thermostat Batterie mit 3 Wegen UP Umstellung für Art. ZA018400 und art. ZA018401
 Mezclador termostático para empotrar con desviador discos cerámicos 3 vías para art. ZA018400 e art. ZA018401

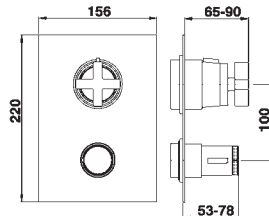

BA 01850 3

Miscelatore termostatico incasso con deviatore a dischi ceramici 4 vie per Art. ZA018500 e art. ZA018501
 Thermostatic concealed mixer with 4 ways ceramic discs diverter for Art. ZA018500 e art. ZA018501
 Mitigeur thermostatique encastré avec inverseur à disques céramiques 4 voies pour art. ZA018500 e art. ZA018501
 Thermostat Batterie mit 4 Wegen UP Umstellung für Art. ZA018500 und art. ZA018501
 Mezclador termostático para empotrar con desviador discos cerámicos 4 vías para art. ZA018500 e art. ZA018501

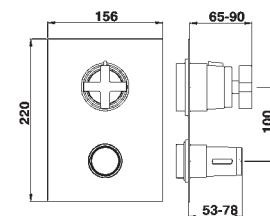

BA 01860 3

Miscelatore termostatico incasso con deviatore a dischi ceramici 6 vie per Art. ZA018600 e art. ZA018601
 Thermostatic concealed mixer with 6 ways ceramic discs diverter for Art. ZA018600 e art. ZA018601
 Mitigeur thermostatique encastré avec inverseur à disques céramiques 6 voies pour art. ZA018600 e art. ZA018601
 Thermostat Batterie mit 6 Wegen UP Umstellung für Art. ZA018600 und art. ZA018601
 Mezclador termostático para empotrar con desviador discos cerámicos 6 vías para art. ZA018600 e art. ZA018601

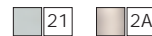

BARCELONA

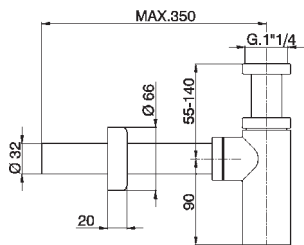

ZA 00404 2

Sifone minimale
Siphon minimal
Siphon minimal
Siphon minimal
Sifón Minimal

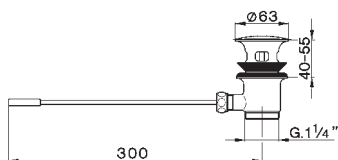

ZA 00580 0

Scarico automatico
Automatic pop-up waste
Vidage automatique
Automatische Ablaufgarnitur
Desagüe automático

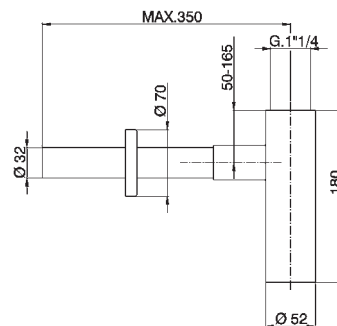

ZA 00407 0

Sifone
Siphon
Siphon
Siphon
Sifón

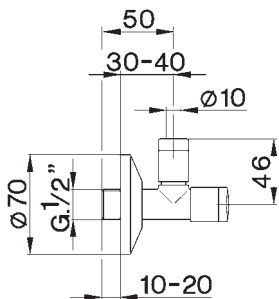
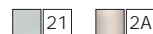

ZA 00290 0

Rubinetto d'alimentazione
Angle supply
Robinet d'alimentation
Eckventil
Grifo de alimentación



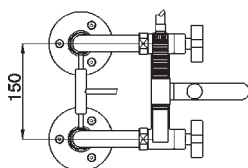
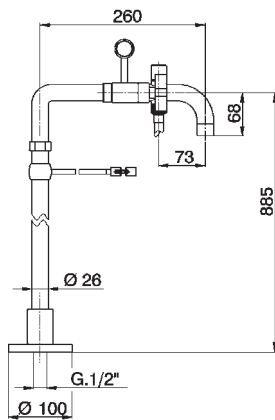
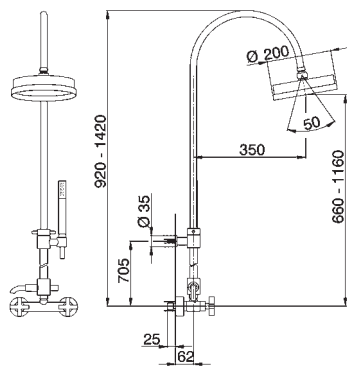

BA 00405 1

Gruppo doccia esterno
 Wall mounted shower mixer
 Mélangeur douche mural
 AP Brausebatterie
 Grupo ducha exterior





BA 00420 0

Gruppo vasca
 Bath mixer
 Mélangeur bain/douche
 Badebatterie
 Grupo bañera





GALLERY







I

-  Braccio doccia
-  Doccetta manuale
-  Bocca di erogazione
-  Soffioni frontali
-  Braccio doccia + soffioni frontali

F

-  Bras de douche
-  Douchette manuelle
-  Bec d'érogation
-  Pomme de douche frontales
-  Bras de douche + pomme de douche frontales





GB

-  Shower arm
-  Handspray
-  Spout
-  Front showerheads
-  Shower arm + front showerheads

D

-  Brausearm
-  Handbrause
-  Auslauf
-  Frontale Brausen
-  Kopfbrausen + Seitenbrause

E

-  brazo ducha
-  ducha manual
-  câno de erogacion
-  rociador frontal
-  brazo ducha+rociador frontal

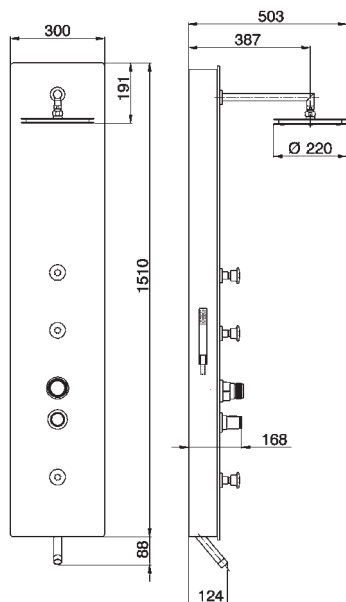

LS 00500 O

Pannello doccia/vasca "COMPACT" LS
 COMPACT shower/bath panel LS
 Panneau douche COMPACT - LS
 Brausepanel COMPACT - LS
 Panel ducha/bañera "COMPACT" LS

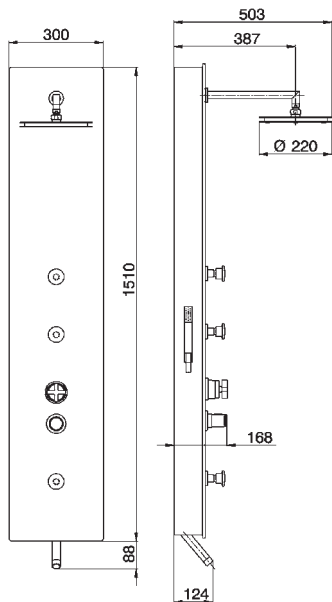

BA 00500 O

Pannello doccia/vasca "COMPACT" BA
 COMPACT shower/bath panel BA
 Panneau douche COMPACT - BA
 Brausepanel COMPACT - BA
 Panel ducha/bañera "COMPACT" BA



GALLERY

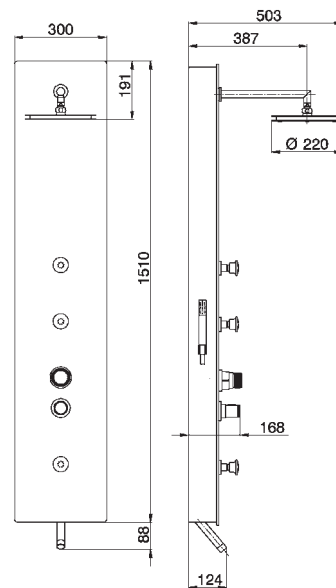
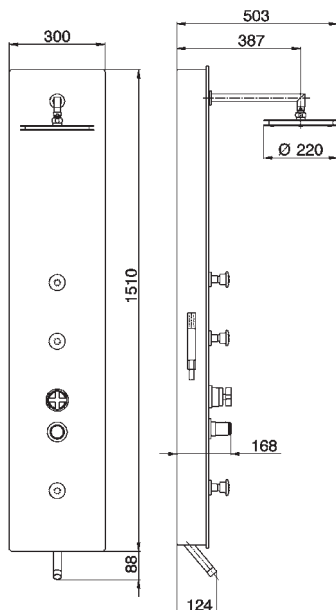
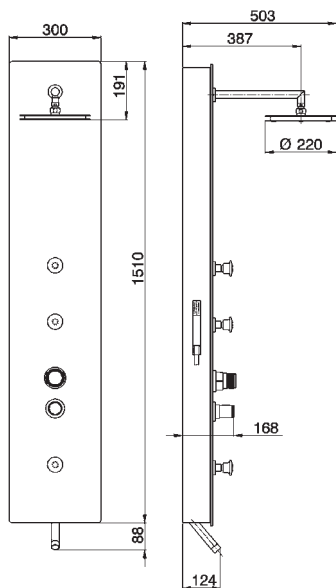

LS 00500 1

Pannello doccia/vasca "COMPACT" LS
 COMPACT shower/bath panel LS
 Panneau douche COMPACT - LS
 Brausepanel COMPACT - LS
 Panel ducha/bañera "COMPACT" LS

BA 00500 2

Pannello doccia/vasca "COMPACT" BA
 COMPACT shower/bath panel BA
 Panneau douche COMPACT - BA
 Brausepanel COMPACT - BA
 Panel ducha/bañera "COMPACT" BA

LS 00500 4

Pannello doccia/vasca "COMPACT" LS
 COMPACT shower/bath panel LS
 Panneau douche COMPACT - LS
 Brausepanel COMPACT - LS
 Panel ducha/bañera "COMPACT" LS



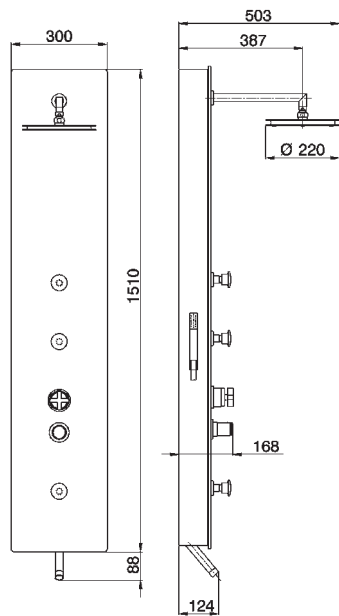

BA 00500 4
 Pannello doccia/vasca "COMPACT" BA
 COMPACT shower/bath panel BA
 Panneau douche COMPACT - BA
 Brausepanel COMPACT - BA
 Panel ducha/bañera "COMPACT" BA

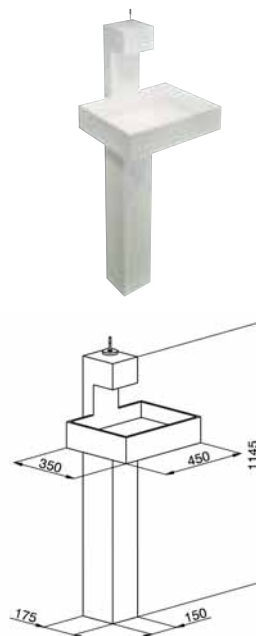

GA 00048 0
 Lavabo a colonna 45x35
 Wash-basin column 45x35
 Colonne lavabo 45x35
 Waschbecken in Säulenform 45x35
 Lavabo de columna 45x35

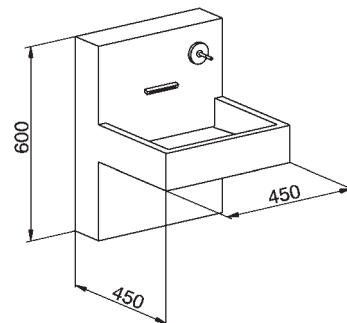

GA 00049 0
 Lavabo 45x45
 Wash-basin 45x45
 Lavabo 45x45
 Waschbecken 45x45
 Lavabo 45x34

GALLERY

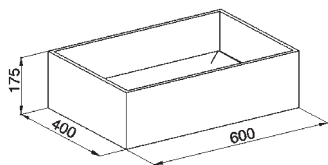

GA 00056 0
 Lavabo 40x60
 Wash-basin 40x60
 Lavabo 40x60
 Waschbecken 40x60
 Lavabo 40x60

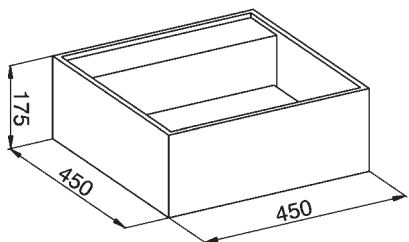

GA 00054 0
 Lavabo 45x45
 Wash-basin 45x45
 Lavabo 45x45
 Waschbecken 45x45
 Lavabo 45x45

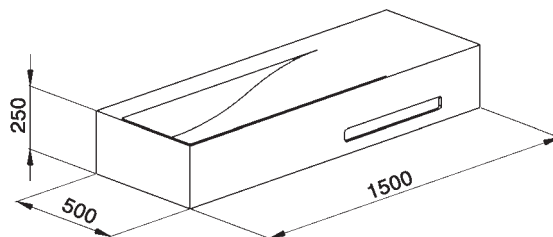

GA 00051 0
 Lavabo 150x50
 Wash-basin 150x50
 Lavabo 150x50
 Waschbecken 150x50
 Lavabo 150x50

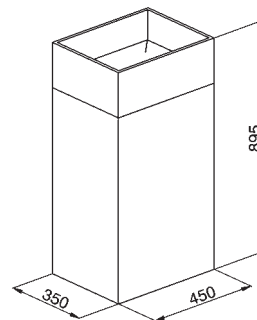

GA 00055 0
 Lavabo a colonna 45x35 H. 90
 Wash-basin column 45x35 H. 90
 Colonne lavabo 45x35 H. 90
 Waschbecken in Säulenform 45x35 H. 90
 Lavabo de columna 45x35 H.90



GALLERY

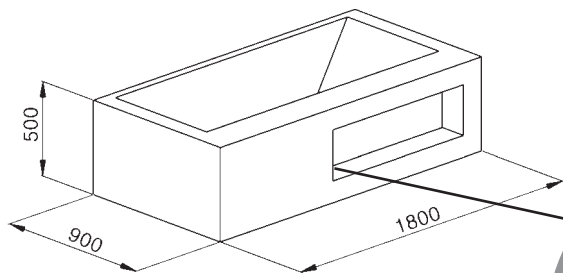

SPORTELLINO PER ISPEZIONE SCARICO VASCA
 INSPECTION PLATE FOR BATH TUB'S DRAIN
 OUVERTURE POUR INSPECTION VIDAGE BAIGNOIRE
 ABDECKPLATTE WANNEN-ABLAUFGARNITUR
 COMPUERTA PARA INSPECCIÓN DESAGÜE BAÑERA

GA 00010 0

Vasca 180x90 H. 50
 Bath tub 180x90 H. 50
 Baignoire 180x90 H. 50
 Badewanne 180x90 H. 50
 Bañera 180x90 H.50



GA 09045 0

Vassoio
 Tray
 Plateau
 Ablage
 Bandeja

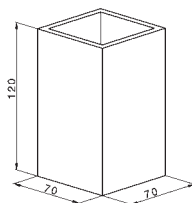

GA 09046 0

Bicchiere
 Glass
 Verre
 Glas
 Vaso small

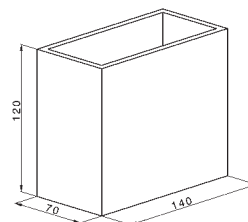

GA 09047 0

Bicchiere maxi
 Maxi glass
 Verre maxi
 Glas maxi
 Vaso large



GALLERY

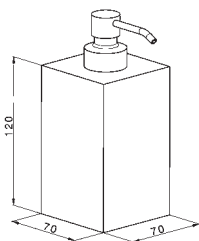

GA 09061 0

Soap dispenser d'appoggio
Surface soap dispenser
Distributeur de savon liquide
Seifenspenderfreistehend
Dispensador de jabón de apoyo



QUAD

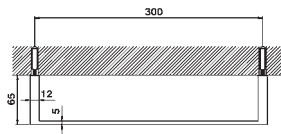
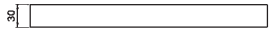

QU 09010 0
 Portasalviette
 Towel holder
 Porte-serviettes
 Handtuchhalter
 Toallero

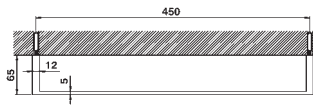

QU 09010 1
 Portasalviette
 Towel holder
 Porte-serviettes
 Handtuchhalter
 Toallero

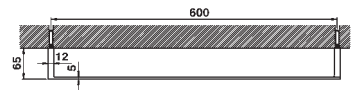
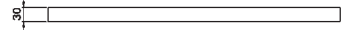

QU 09010 2
 Portasalviette
 Towel holder
 Porte-serviettes
 Handtuchhalter Spagnolo
 Toallero

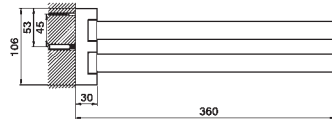

QU 09021 0
 Portasalviette doppio a muro
 Twin towel holder - pivot arms
 Porte-serviettes double mural
 Doppel Handtuchhalter
 schwenkbar Spagnolo
 Toallero doble de pared

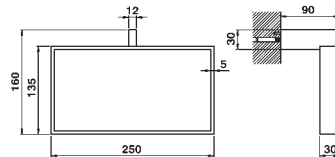

QU 09022 0
 Portasalviette ad anello
 Ring-shaped towel holder
 Porte-serviettes à anneau
 Ringformiger Handtuchhalter Spagnolo
 Toallero anillo

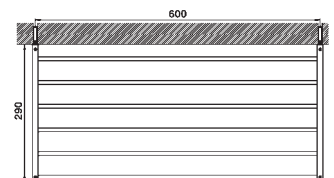

QU 09030 0
 Griglia portasalviette
 Towel rack
 Etagère serviettes
 Handtuchablage Spagnolo
 Secador toallas



QUAD

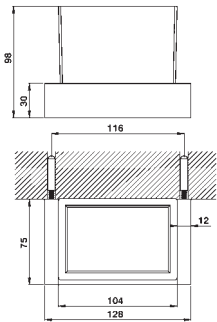

QU 09050 0
 Porta bicchiere
 Glass holder
 Porte verre
 GlashalterSpagnolo
 Portavasos

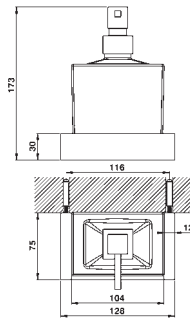

QU 09062 0
 Porta soap dispenser
 Holder for soap dispenser
 Appui pour porte savon liquide
 Halter für SeifenspenderSpagnolo
 Porta-dispensador de jabón

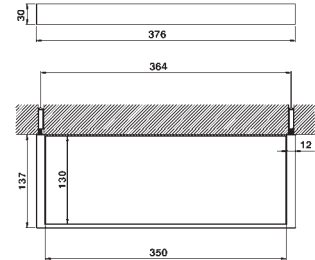

QU 09044 0
 Porta mensola
 Shelf's holder
 Appui pour console
 KonsoleSpagnolo
 Portarepisa

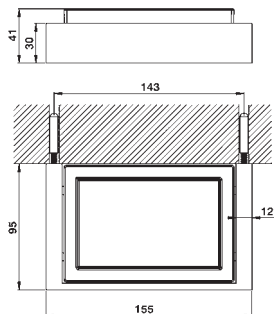

QU 09060 0
 Porta sapone
 Soap holder
 Porte-savon
 SeifenhalterSpagnolo
 Jabonera

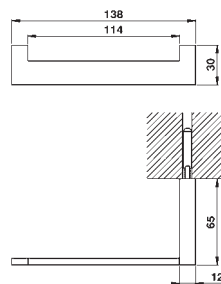
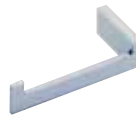

QU 09040 0
 Porta rotolo
 Toilet paper holder
 Porte-papier
 PapierrollenhalterSpagnolo
 Portarrotolo

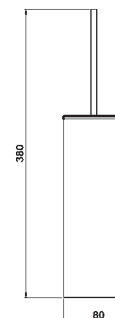

QU 09065 0
 Porta scopino
 Brush holder
 Porte-balai W.C.
 WC-BürstengarniturSpagnolo
 Portaescobilla



QUAD

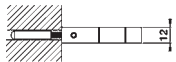
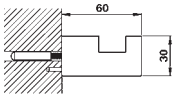

QU 09071 0
Appendino singolo
Single hook
Crochet simple
Einzelwandhaken
Percha simple

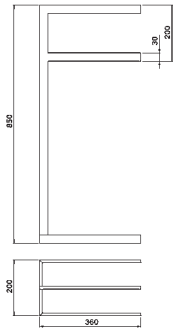

QU 09091 0
Piantana Lavabo
Standing set
Porte-serviettes combiné de lavabo
Handtuchständer
Manguito roscado lavabo



SYSTEM

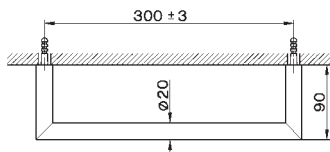

SY 09010 0

Porta salviette cm. 30
Towel holder cm. 30
Porte-serviettes cm. 30
Handtuchhalter cm. 30
Toallero cm. 30

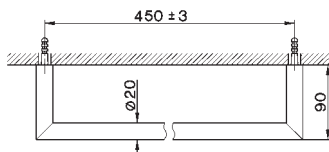

SY 09010 1

Porta salviette cm. 45
Towel holder cm. 45
Porte-serviettes cm. 45
Handtuchhalter cm. 45
Toallero cm. 45

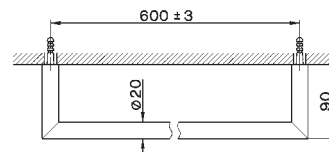

SY 09010 2

Porta salviette cm. 60
Towel holder cm. 60
Porte-serviettes cm. 60
Handtuchhalter cm. 60
Toallero cm. 60

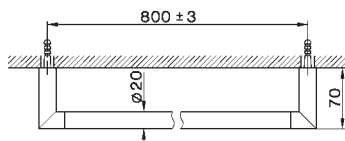
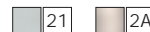

SY 09010 3

Porta salviette cm. 80
Towel holder cm. 80
Porte-serviettes cm. 80
Handtuchhalter cm. 80
Toallero cm. 80

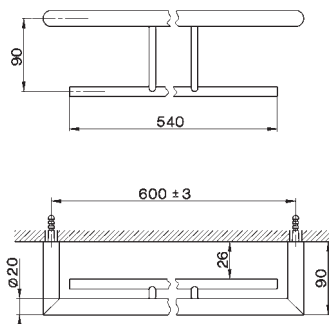

SY 09020 0

Porta salviette doppio
Double towel holder
Porte-serviettes double
Doppel Handtuchhalter
Toallero doble

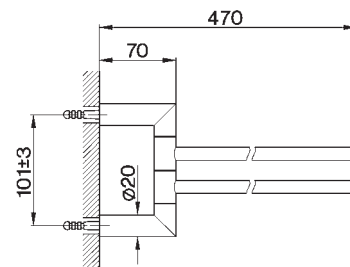

SY 09021 0

Porta salviette doppio a muro
Twin towel holder - pivot arms
Porte-serviettes double mural
Doppel Handtuchhalter - schwenkbar
Toallero doble de pared

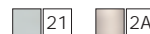

SYSTEM

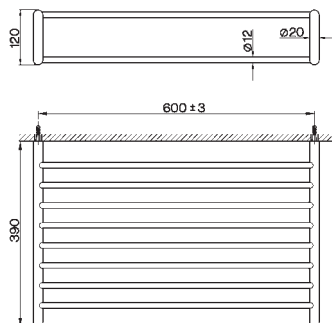

SY 09030 0
 Griglia porta salviette
 Towel rack
 Étagère serviettes
 Handtuchablage
 Toallero de rejilla

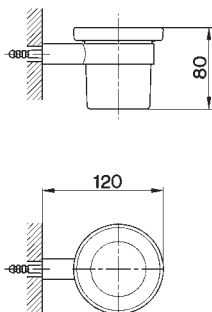

SY 09050 0
 Porta bicchiere
 Glass holder
 Porte-verre
 Glashalter
 Portavasos

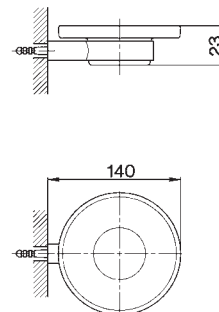

SY 09060 0
 Porta sapone
 Soap holder
 Porte-savon
 Seifenhalter
 Jabonera

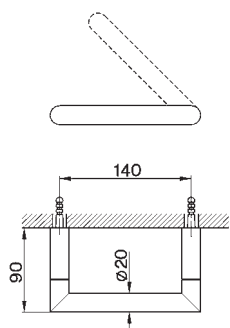
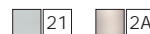

SY 09040 0
 Porta rotolo
 Toilet paper holder
 Porte-papier
 Papierrollenhalter
 Portarrollo

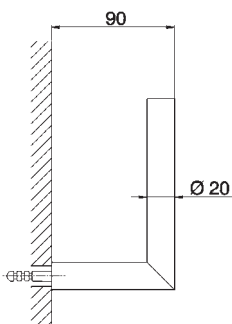

SY 09041 0
 Porta rotolo di riserva
 Toilet paper holder reserve
 Porte-papier de réserve
 Papierrollenhalter als Vorrat
 Portarrollo de recambio

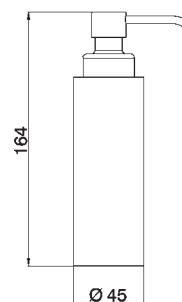

SY 09061 0
 Soap dispenser d'appoggio
 Surface soap dispenser
 Distributeur de savon liquide
 Seifenspenderfreistehend
 Dispensador de jabón de apoyo

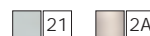

SYSTEM

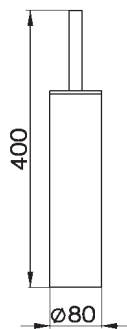

SY 09065 0
 Porta scopino
 Brush holder
 Porte-balay W.C.
 WC-Bürstengarnitur
 Portaescobilla

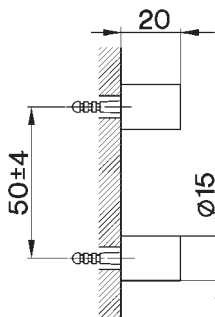

SY 09066 0
 Set di installazione porta scopino
 a muro
 Set de instalación para porta escobilla
 a pared
 Toilet brushed holder
 Juego de instalación portaescobilla
 de pared

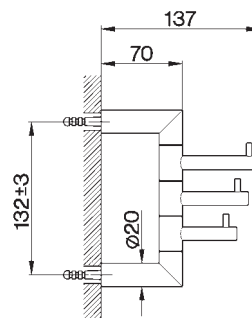

SY 09070 0
 Appendino multiplo
 Multiple hooks
 Crochets multiple
 Mehrfachwandhaken
 Percha múltiple

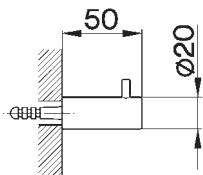
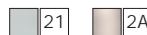

SY 09071 0
 Appendino singolo
 Single hook
 Crochet single
 Einzelwandhaken
 Percha simple

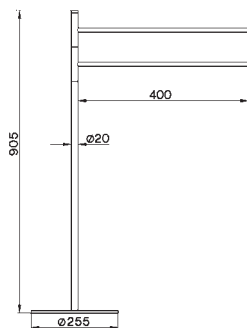

SY 09091 0
 Piantana Lavabo
 Standing set
 Porte-serviettes combiné de lavabo
 Handtuchständer
 Manguito roscado lavabo



FINITURE - FINISHINGS - FINITIONS - OBERFLÄCHEN - ACABADOS



Cromo
Chrome
Chrome
Chrom
Cromo



Nichel
satinato spazzolato
Satin
brushed nickel
Nickel satiné
Nickel satin
Nickel satinado
patinado



Nichel
Sat. spazzolato/cromo
Satin brushed
nickel/chrome
Nickel satiné/chrome
Nickel satin/Chrom
Nickel satinado
patinado/cromo



Cromo/nichel
Satinato spazzolato
Chrome/satin
brushed nickel
Chrome/nickel satiné
Chrom/Nickel satin
Cromo/nichel



Corian® Glacier White
Corian® Glacier White
Corian® Glacier White
Corian® Glacier White
Corian® Glacier White



Rubinetteria CISAL S.p.A
28010 Pella frazione Alzo (Novara) - ITALY
Via P. Durio, 160
Tel. 0322.918111
Telefax 0322.969518



E-mail: cisal@cisal.it - www.cisal.it

CISAL Sanitär Armaturen Vertriebs-GmbH
Gewerbestrasse 8
91452 Wilhermsdorf - Germany
Tel. 09102 / 9382-0
Telefax 09102 / 9382-82

E-mail: info@cisal.de - www.cisal.de