



COLORDESIGN_DOMINO MOSAICI







DI COLORE IN COLORE



FROM COLOUR TO COLOUR
DE COLOR EN COLOR
VON EINER FARBE ZUR ANDEREN
DE COULEUR EN COULEUR

C O L O R D E S I G N





COLORDESIGN

COLORDESIGN 20x20

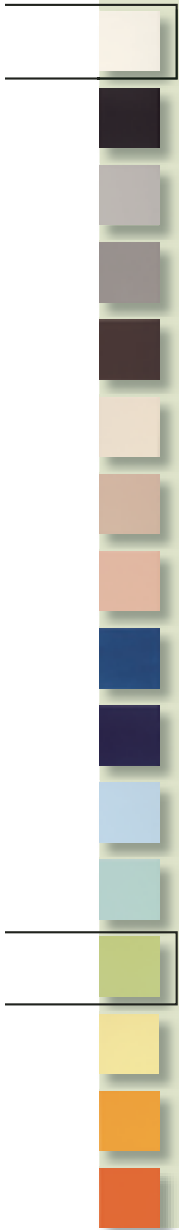

GIGLIO

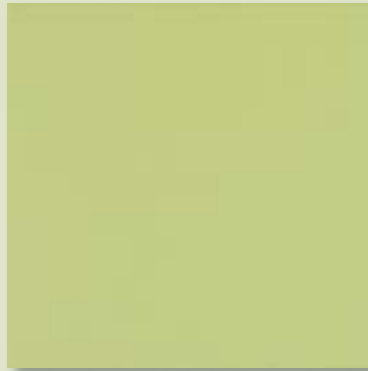

MENTA





COLORDESIGN

COLORDESIGN

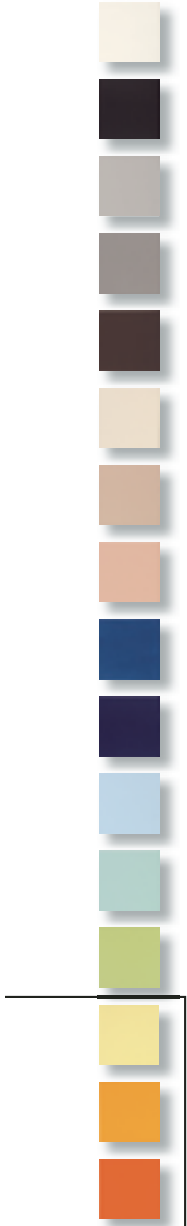

20x20

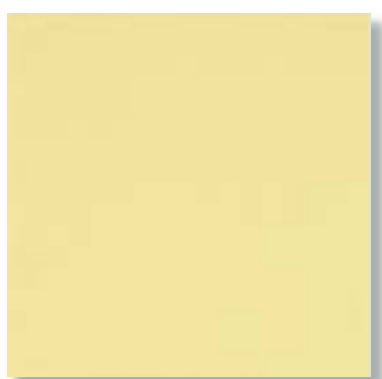

PAPIRO

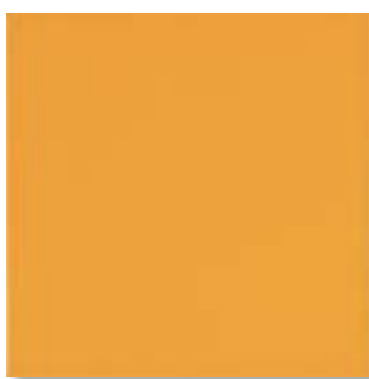

LIME



ZAFFERANO



COLORDESIGN

COLORDESIGN 20x20



CREMA



SABBIA





20x20

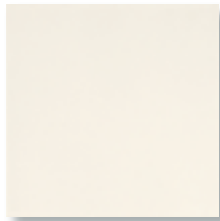

713645 20x20 GIGLIO
PEI V GLA  

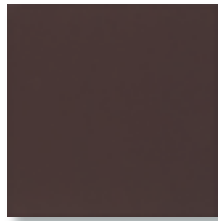

713648 20x20 LAVA
PEI II GLA  

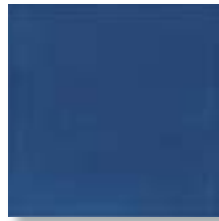

713657 20x20 GLICINE
PEI II GLA  

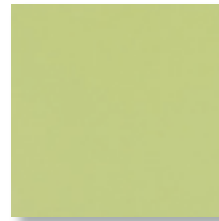

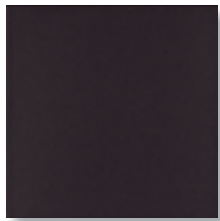

713660 20x20 MENTA
PEI III GLA  



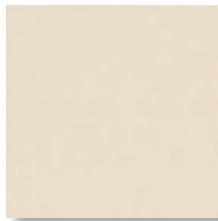

713649 20x20 PETROLIO
PEI II GLA  





713650 20x20 CREMA
PEI IV GLA  

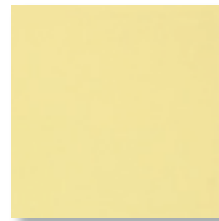

713658 20x20 PRUSSIA
PEI II GLA  



713653 20x20 PAPIRO
PEI IV GLA  

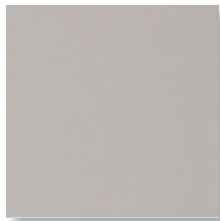

713646 20x20 POLVERE
PEI IV GLA  

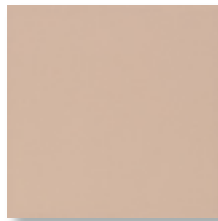

713651 20x20 SABBIA
PEI IV GLA  

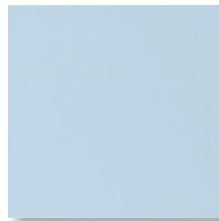

713656 20x20 GHIACCIO
PEI IV GLA  



713654 20x20 LIME
PEI III GLA  



713647 20x20 SETA
PEI III GLA  

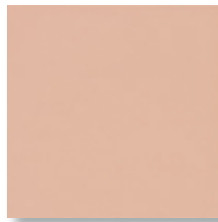

713652 20x20 ROSA
PEI IV GLA  

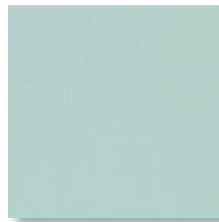

713659 20x20 CARAIBI
PEI III GLA  



713655 20x20 ZAFFERANO
PEI II GLA  

PEZZI SPECIALI

TRIMS/PIECES SPECIALES/FORMSTUCKE/PIEZAS ESPECIALES

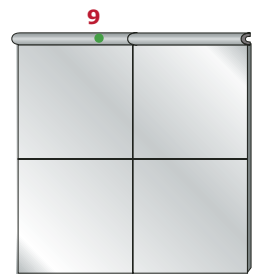
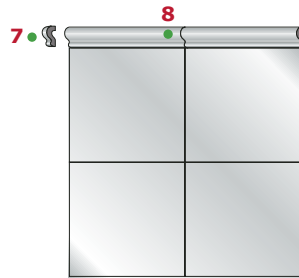
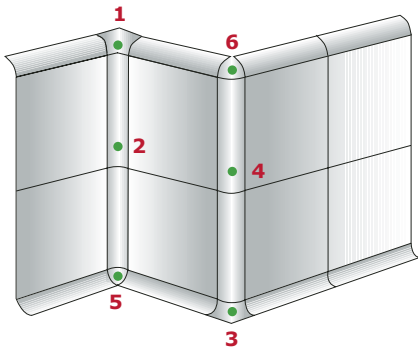

1 PIÈ D'OCA INT. 2,5x2,5

712915 GIGLIO
712917 POLVERE
712919 SETA
712921 LAVA
712923 PETROLIO
712925 CREMA
712927 SABBIA
712929 ROSA
712931 PAPIRO
712933 LIME
712935 ZAFFERANO
712937 GHIACCIO
712939 GLICINE
712941 PRUSSIA
712943 CARAIBI
712945 MENTA

2 CANALETTA INT. 2,5x20

712401 GIGLIO
712403 POLVERE
712405 SETA
712407 LAVA
712409 PETROLIO
712411 CREMA
712413 SABBIA
712415 ROSA
712417 PAPIRO
712419 LIME
712421 ZAFFERANO
712423 GHIACCIO
712425 GLICINE
712427 PRUSSIA
712429 CARAIBI
712431 MENTA

3 PIÈ D'OCA EST. 2,5x2,5

712916 GIGLIO
712918 POLVERE
712920 SETA
712922 LAVA
712924 PETROLIO
712926 CREMA
712928 SABBIA
712930 ROSA
712932 PAPIRO
712934 LIME
712936 ZAFFERANO
712938 GHIACCIO
712940 GLICINE
712942 PRUSSIA
712944 CARAIBI
712946 MENTA

4 CANALETTA EST. 2,5x20

712402 GIGLIO
712404 POLVERE
712406 SETA
712408 LAVA
712410 PETROLIO
712412 CREMA
712414 SABBIA
712416 ROSA
712418 PAPIRO
712420 LIME
712422 ZAFFERANO
712424 GHIACCIO
712426 GLICINE
712428 PRUSSIA
712430 CARAIBI
712432 MENTA

5 CONCHIGLIA INT. 2,5x2,5

712861 GIGLIO
712863 POLVERE
712865 SETA
712867 LAVA
712869 PETROLIO
712871 CREMA
712873 SABBIA
712875 ROSA
712877 PAPIRO
712879 LIME
712881 ZAFFERANO
712883 GHIACCIO
712885 GLICINE
712887 PRUSSIA
712889 CARAIBI
712891 MENTA

6 CONCHIGLIA EST. 2,5x2,5

712862 GIGLIO
712864 POLVERE
712866 SETA
712868 LAVA
712870 PETROLIO
712872 CREMA
712874 SABBIA
712876 ROSA
712878 PAPIRO
712880 LIME
712882 ZAFFERANO
712884 GHIACCIO
712886 GLICINE
712888 PRUSSIA
712890 CARAIBI
712892 MENTA

7 SPIG. TORELLO 2,5x2,5

712979 GIGLIO
712980 POLVERE
712981 SETA
712982 LAVA
712983 PETROLIO
712984 CREMA
712985 SABBIA
712986 ROSA
712987 PAPIRO
712988 LIME
712989 ZAFFERANO
712990 GHIACCIO
712991 GLICINE
712992 PRUSSIA
712993 CARAIBI
712994 MENTA

8 TORELLO 2,5x20

712479 GIGLIO
712480 POLVERE
712481 SETA
712482 LAVA
712483 PETROLIO
712484 CREMA
712485 SABBIA
712486 ROSA
712487 PAPIRO
712488 LIME
712489 ZAFFERANO
712490 GHIACCIO
712491 GLICINE
712492 PRUSSIA
712493 CARAIBI
712494 MENTA

9 MATITA 1,2x20

712101 GIGLIO
712102 POLVERE
712103 SETA
712104 LAVA
712105 PETROLIO
712106 CREMA
712107 SABBIA
712108 ROSA
712109 PAPIRO
712110 LIME
712111 ZAFFERANO
712112 GHIACCIO
712113 GLICINE
712114 PRUSSIA
712115 CARAIBI
712116 MENTA

pezzi speciali
trims / pièces spéciales
formstücke / piezas especiales

	articoli items / artículos Artikel / artículos	codici codes / code Artikelnummern / códigos	imballi packing / conditionnement Verpackungseinheiten / embalajes
Jolly	GIGLIO	713661	
	POLVERE	713662	
	SETA	713663	
	LAVA	713664	
	PETROLIO	713665	
	CREMA	713666	
	SABBIA	713667	
	ROSA	713668	
	PAPIRO	713669	
	LIME	713670	
	ZAFFERANO	713671	
	GHIACCIO	713672	
	GLICINE	713673	
	PRUSSIA	713674	
	CARAIBI	713675	
20x20	MENTA	713676	

DOMINO MOSAICI

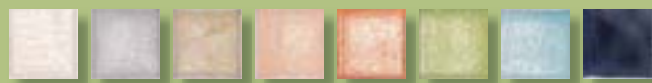



**DOMINO
MOSAICI**



DOMINO MOSAICI 20x20

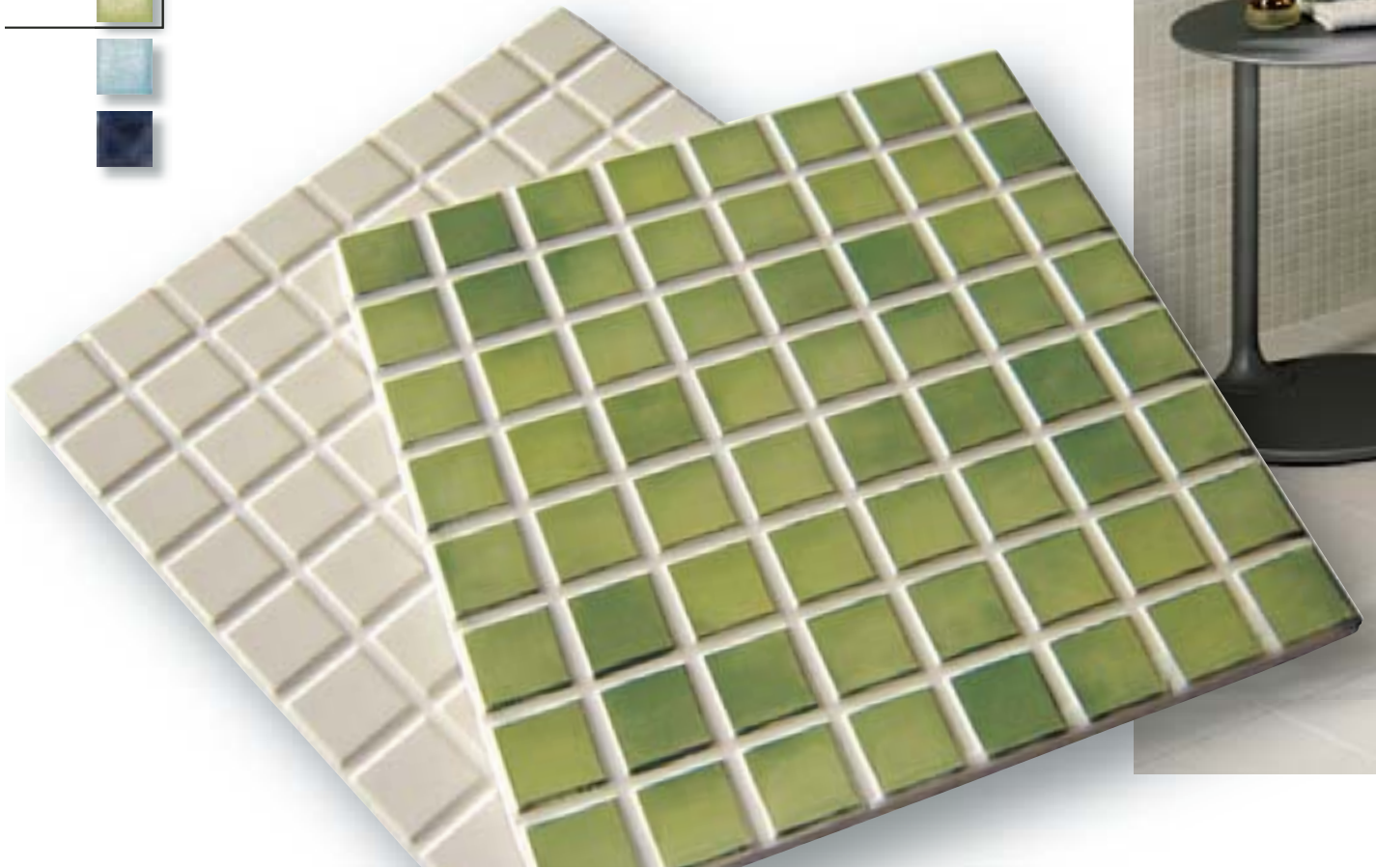



**DOMINO
MOSAICI**



DOMINO MOSAICI 20x20

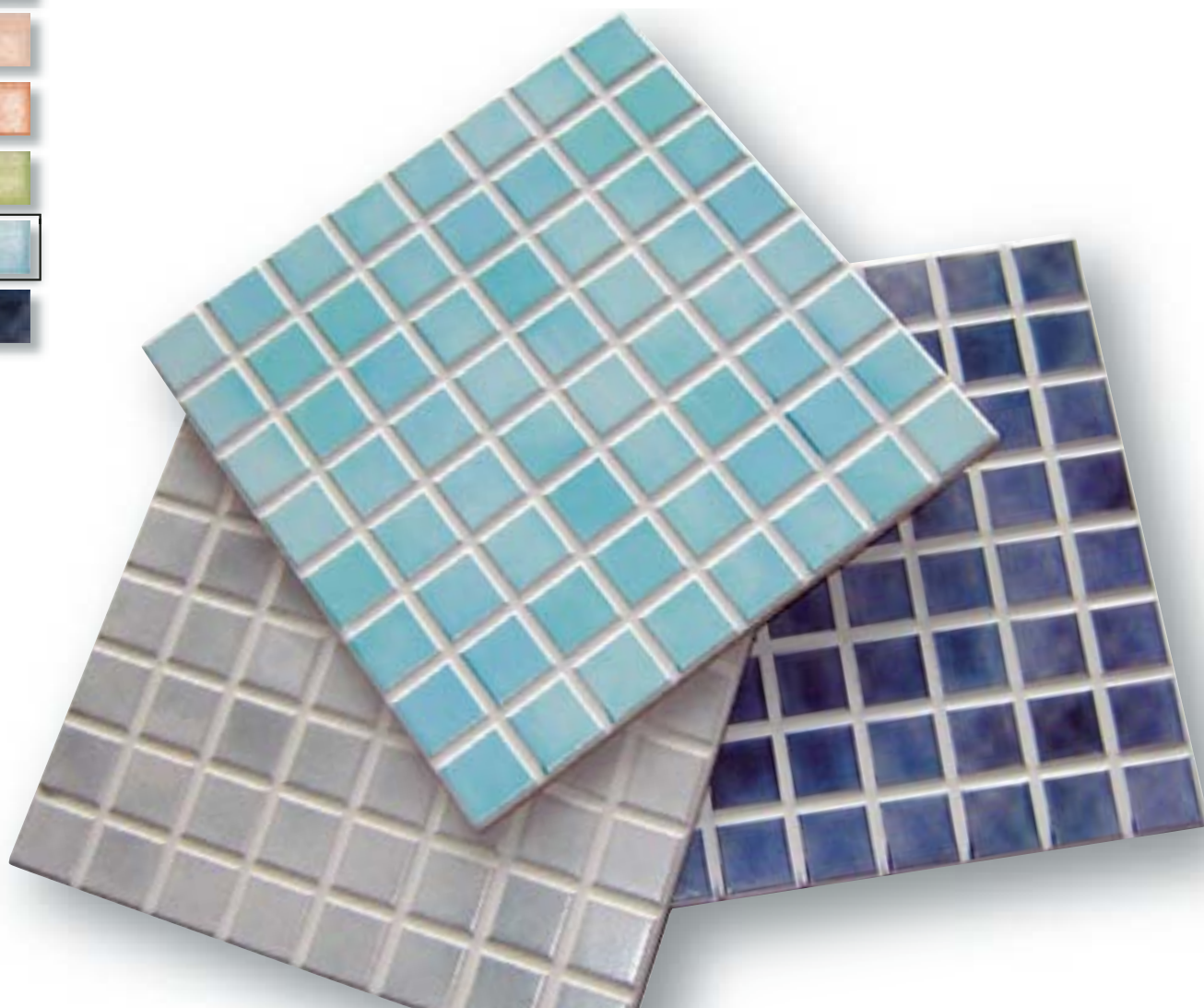



DOMINO MOSAICI

20x20



563103 20x20
DOMINO BIANCO GLA



563104 20x20
DOMINO BEIGE GLA

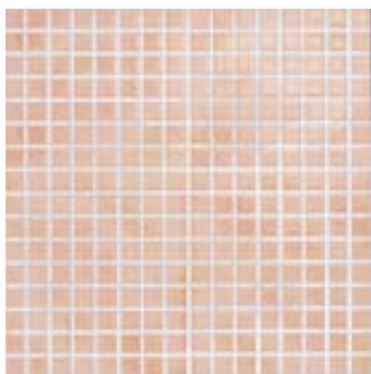

563105 20x20
DOMINO ROSA GLA

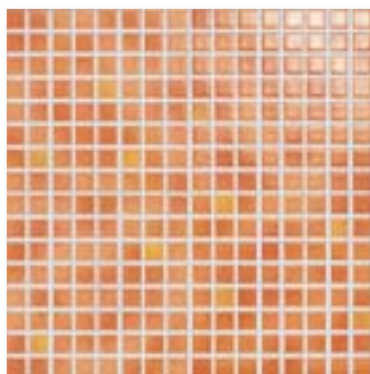

563106 20x20
DOMINO ARANCIO GLA

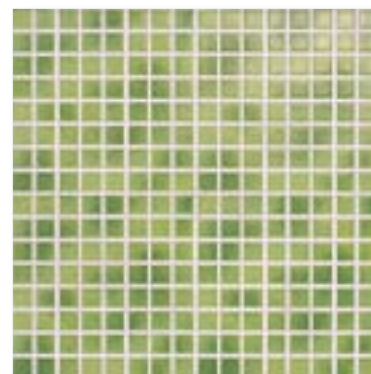

563107 20x20
DOMINO VERDE GLA



563108 20x20
DOMINO AZZURRO GLA



563109 20x20
DOMINO BLU GLA

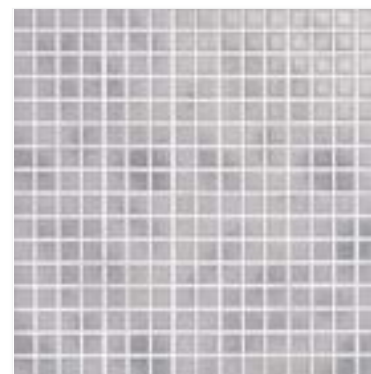

563110 20x20
DOMINO GRIGIO GLA



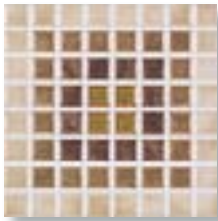

563131 20x20
MOS. QUADRO BEIGE (43)

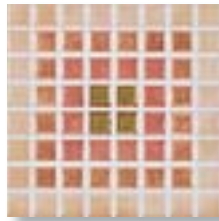

563132 20x20
MOS. QUADRO ROSA (43)

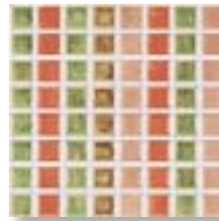

563137 20x20
MOS. RIGHE ARANCIO (43)



563138 20x20
MOS. RIGHE BLU (43)

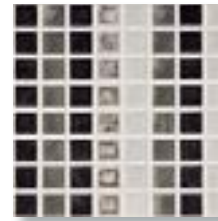

563139 20x20
MOS. RIGHE GRIGIO (43)

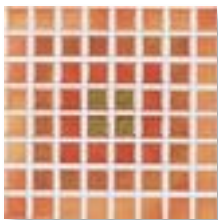

563133 20x20
MOS. QUAD. ARANCIO (43)



563134 20x20
MOS. QUADRO VERDE (43)



758404 5x20
LIST. MOS. RIGHE ARANCIO (14)



758405 5x20
LIST. MOS. RIGHE BLU (14)

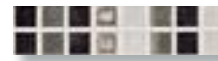

758406 5x20
LIST. MOS. RIGHE GRIGIO (14)

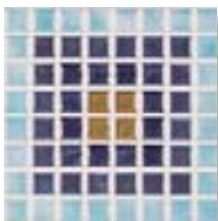

563135 20x20
MOS. QUADRO BLU (43)

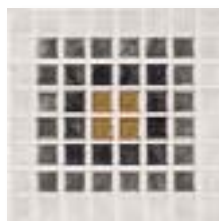

563136 20x20
MOS. QUADRO GRIGIO (43)



563140 20x20
MOS. FIORI ARANCIO (43)



563141 20x20
MOS. FIORI VERDE (43)



563142 20x20
MOS. FIORI BLU (43)



758407 5x20
LIST. MOS. FIORI ARANCIO (14)



758408 5x20
LIST. MOS. FIORI VERDE (14)



758409 5x20
LIST. MOS. FIORI BLU (14)

pezzi speciali
trims
pièces spéciales
formstücke
piezas especiales

articoli
items
articles
Artikel
artículos

codici
codes
code
Artikelnummern
códigos

imballi
packing
conditionnement
Verpackungseiheiten
embalajes

	Jolly	DOMINO BIANCO		563143	
		DOMINO BEIGE		563144	
		DOMINO ROSA		563145	
		DOMINO ARANCIO		563146	
		DOMINO VERDE		563147	
		DOMINO AZZURRO		563148	
		DOMINO BLU		563149	
20x20		DOMINO GRIGIO		563150	

20x20

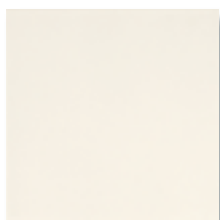

713645 20x20 GIGLIO
PEI IV GLA 15 35



713646 20x20 POLVERE
PEI IV GLA 15 35



713656 20x20 GHIACCIO
PEI IV GLA 16 35



713655 20x20 ZAFFERANO
PEI II GLA 35 35



713651 20x20 SABBIA
PEI IV GLA 15 35



713652 20x20 ROSA
PEI IV GLA 15 35



713660 20x20 MENTA
PEI III GLA 16 35



713658 20x20 PRUSSIA
PEI II GLA 20 35

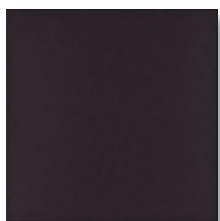

713649 20x20 PETROLIO
PEI II GLA 16 35



713650 20x20 CREMA
PEI IV GLA 15 35



712979 2,5x2,5
SPIG. TORELLO GIGLIO 13 2



712479 2,5x20
TORELLO GIGLIO 13 6



712980 2,5x2,5
SPIG. TORELLO POLVERE 13 2



712480 2,5x20
TORELLO POLVERE 13 6



712990 2,5x2,5
SPIG. TORELLO GHIACCIO 13 2



712490 2,5x20
TORELLO GHIACCIO 13 6



712985 2,5x2,5
SPIG. TORELLO SABBIA 13 2



712485 2,5x20
TORELLO SABBIA 13 6



712986 2,5x2,5
SPIG. TORELLO ROSA 13 2



712486 2,5x20
TORELLO ROSA 13 6



712989 2,5x2,5
SPIG. TORELLO ZAFFERANO 13 2



712489 2,5x20
TORELLO ZAFFERANO 13 6



712994 2,5x2,5
SPIG. TORELLO MENTA 13 2



712494 2,5x20
TORELLO MENTA 13 6



712992 2,5x2,5
SPIG. TORELLO PRUSSIA 13 2



712492 2,5x20
TORELLO PRUSSIA 13 6



712983 2,5x2,5
SPIG. TORELLO PETROLIO 13 2



712483 2,5x20
TORELLO PETROLIO 13 6



712984 2,5x2,5
SPIG. TORELLO CREMA 13 2



712484 2,5x20
TORELLO CREMA 13 6



MATITA 1,2x20 11 6

- 712101 MATITA GIGLIO
- 712102 MATITA POLVERE
- 712105 MATITA PETROLIO
- 712106 MATITA CREMA
- 712107 MATITA SABBIA
- 712108 MATITA ROSA
- 712111 MATITA ZAFFERANO
- 712112 MATITA GHIACCIO
- 712114 MATITA PRUSSIA
- 712116 MATITA MENTA

MERCHANDISING



LCG015 Catalogo
COLORDESIGN
DOMINO MOSAICI



GL0098
Tozzettario
COLORDESIGN

LCG036 Pocket
COLORDESIGN
DOMINO MOSAICI



LPM 933 Espositore
COLORDESIGN - DOMINO MOSAICI

PANNELLI 100.5x192



GKD043 PANNELLO
COLORDESIGN



CKP986 PANNELLO
DOMINO MOSAICI



CKP987 PANNELLO
DOMINO MOSAICI

CARATTERISTICHE TECNICHE

technical characteristics | caractéristiques techniques | technische Eigenschaften | Características Técnicas



Classificazione secondo norme	EN 14411	Alegato L	gruppo B III
Classification in accordance with	EN 14411	Annexe L	grupo B III
Klassifizierung gemäß	EN 14411	Normen Anlage L	gruppe B III
Classification selon les normes	EN 14411	Annexe L	groupe B III
Clasificación según normas	EN 14411	Adjunto L	grupo B III

		Tipo di prova Standard of test Testnorm Norme du test Tipo de pruebas	Valore prescritto Required value Vorgeschriebener Wert Valeur prescrite Valor prescrito	
DIMENSIONI sizes abmessungen dimensions dimensiones	ISO 10545.2	Lunghezza e larghezza Length and width Länge und Breite Longueur et largeur Largura y anchura ± 0,5% Spessore Thickness Stärke Epaisseur Espesor ± 10% Rettilinearità spigoli Linearity Kantengeradheit Rectitude des arêtes Rectilineidad cantos ± 0,3% Ortogonalità Wedging Rechtwinkligkeit Ort hogonalité Ortogonalidad ± 0,5% Planarità Warpage Ebenflächigkeit Planéité Planitud + 0,5% - 0,3%	± 0,5% ± 5% ± 0,3% ± 0,4% ± 0,3%	
ASSORBIMENTO D'ACQUA water absorption wasseraufnahme absorption d'eau absorción de agua	ISO 10545.3	> 10%	~ 16%	
RESISTENZA ALLA FLESSIONE flexion resistance biegefestigkeit resistance à la flexion resistencia a la flexión	ISO 10545.4	Spessore > 7,5 mm. 12 N/mm ² Stärke ≥ 7,5 mm. 15 N/mm ⁵ Epaisseur Espesor	19 N/mm ² 22 N/mm ²	
RESISTENZA ALL'ABRASIONE resistance to abrasion abriebhärte résistance à l'abrasion resistencia a la abrasión	ISO 10545.7	Secondo i dati del costruttore According to manufacturer's data Laut Angaben des Herstellers Selon les éléments du constructeur Según los datos del constructor	Indicata sul catalogo Indicated in the catalogue Im Katalog angegeben Indiquée dans le catalogue Indicada en el catálogo	
COEFFICIENTE DI DILATAZIONE TERMICA LINEARE coefficient of linear thermal-expansion/lineare wärmeausdehnungskoeffizient coefficiente lineare de dilatation thermique coeficiente de dilatación térmica lineal	ISO 10545.8	Test method available	≤ 8x10 ⁻⁶ °C ⁻¹	
RESISTENZA AGLI SBALZI TERMICI resistance to thermal shock temperaturwechselbeständigkeit résistance aux variations thermiques resistencia a los cambios de temperatura	ISO 10545.9	Test method available	Garantita Guaranteed Garantiert Garantie Garantizada	
RESISTENZA AL CAVILLO crazing resistance haarrißbeständigkeit résistance au tressillage resistencia al agrietado	ISO 10545.11	Richiesta Required Erforderlich Requise Requerida	Garantita Guaranteed Garantiert Garantie Garantizada	
RESISTENZA AL GELO frost resistance frostbeständigkeit résistance au gel resistencia a las heladas	ISO 10545.12	No No Nein Non No	No No Nein Non No	
RESISTENZA AI PRODOTTI CHIMICI chemical resistance chemikalienfestigkeit résistance aux produits chimiques resistencia a los productos químicos	ISO 10545.13	Test method available	Indicata sul catalogo Indicated in the catalogue Im Katalog angegeben Indiquée dans le catalogue Indicada en el catálogo	



Classificazione secondo norme	EN 14411	Allegato G	gruppo B I a
Classification in accordance with	EN 14411	Annexe G	gruppo B I a
Klassifizierung gemäß	EN 14411	Normen Anlage G	gruppe B I a
Classification selon les normes	EN 14411	Annexe G	groupe B I a
Clasificación según normas	EN 14411	Adjunto G	grupo B I a

Proprietà fisico-chimiche Physical-chemical properties Physikalisch-chemische Eigenschaften Propriétés physico-chimiques Propiedades físico-químicas	Tipo di prova Standard of test Testnorm Norme du test Tipo de pruebas	Valore prescritto Required value Vorgeschriebener Wert Valeur prescrite Valor prescrito	Valore Medio Mean value - Mittelwert Valeur moyenne - Valor medio
DIMENSIONI sizes abmessungen dimensions dimensiones	ISO 10545.2	Lunghezza e larghezza Length and width Länge und Breite Longueur et largeur Largura y anchura ± 0,6% max Spessore Thickness Stärke Epaisseur Espesor ± 5% max Rettilinearità spigoli Linearity Kantengeradheit Rectitude des arêtes Rectilineidad cantos ± 0,5% max Ortogonalità Wedging Rechtwinkligkeit Ortogonalität Ortogonalidad ± 0,6% max Planarità Warpage Ebenföchigkeit Planité Planitud ± 0,5% max	± 0,2% ± 2% ± 0,2% ± 0,2% ± 0,2%
ASSORBIMENTO D'ACQUA water absorption wasseraufnahme absorption d'eau absorción de agua	ISO 10545.3	≤ 0,5%	0,04%
RESISTENZA ALLA FLESSIONE flexion resistance biegefestigkeit resistance a la flexion resistencia a la flexión	ISO 10545.4	Breaking Strength: Thickness ≥ 7,5mm.: not less than 1300 N Thickness ≥ 7,5mm.: not less than 700 N Modulus of Rupture: Minimum 35 N/mm ²	> 1700 N * 55 N / mm ² *
RESISTENZA ALL'ABRASIONE resistance to abrasion abriebhärte résistance à l'abrasion resistencia a la abrasión	ISO 10545.7	Secondo i dati del costruttore According to manufacturer's data Laut Angaben des Herstellers Selon les éléments du constructeur Según los datos del constructor	Indicata sul catalogo Indicated in the catalogue Im Katalog angegeben Indiquée dans le catalogue Indicada en el catálogo
COEFFICIENTE DI DILATAZIONE TERMICA LINEARE coefficient of linear thermal-expansion/linearer wärmeausdehnungskoeffizient coefficient lineaire de dilatation thermique coefficiente de dilatación térmica lineal	ISO 10545.8	Test method available	6,5x10 ⁻⁶ °K ⁻¹
RESISTENZA AGLI SBALZI TERMICI resistance to thermal shock temperaturwechselbeständigkeit résistance aux variations thermiques resistencia a los cambios de temperatura	ISO 10545.9	Test method available	Garantita Guaranteed Garantiert Garantie Garantizada
RESISTENZA AL GELO frost resistance frostbeständigkeit résistance au gel resistencia a las heladas	ISO 10545.12	Non devono presentare rotture o alterazioni apprezzabili della superficie Must not produce noticeable alteration to surface Oberflächen dürfen keinen Bruch oder Schaden aufweisen Ne doivent pas présenter des ruptures ou altérations trop importantes de la surface No deben presentar roturas o alteraciones apreciables de la superficie	Non gelive Frost-proof Frostsicher Non gelives Resistente a las heladas
RESISTENZA AI PRODOTTI CHIMICI chemical resistance chemikalienfestigkeit résistance aux produits chimiques resistencia a los productos químicos	ISO 10545.13	Non devono presentare apprezzabili segni d'attacco chimico Must not produce noticeable signs of chemical attack Sie dürfen keine sichtlichen Zeichen einer chemischen Zersetzung vorweisen Ne doivent pas présenter des signes trop évidents à l'attaque chimique No deben presentar apreciables señales de ataque químico	Non attaccate Not attacked Nicht angegriffen Non attaccées No atacados
RESISTENZA ALLE MACCHIE stain resistance fleckenbeständigkeit résistance aux taches resistencia a las manchas	ISO 10545.14	1<X<5	CLASSE 5 Macchie rimosse con acqua corrente calda (senza detergente). Stains removed by hot running water (without detergent). Fleckenentfernung mit fließendem warmen Wasser (ohne Reinigungsmittel). Taches enlevées à l'eau courante chaude (sans détergent). Manchas que se pueden retirar con agua corriente caliente (sin detergente).

* : size 33,3x33,3

COLORDESIGN

IMBALLI • PACKING • CONDITIONNEMENT • VERPACKUNGSEINHEITEN • EMBALAJES

FORMATO SIZE - FORMAT FORMAT - FORMATO	SPESSORE THICKNESS - EPAISSEUR STÄRKE - ESPESOR	KG/MQ KG/SQ.M - KG/M2 KG/QM - KG/M2	SCATOLA BOX - BOÎTE KARTON - CAJA	EUROPALLET	
CM	MM		PZ. MQ.	BOX	MQ.

NATURGRESS					
20x20	6,8	14,70	35	1,40	76 106,40

DOMINO MOSAICI

IMBALLI • PACKING • CONDITIONNEMENT • VERPACKUNGSEINHEITEN • EMBALAJES

FORMATO SIZE - FORMAT FORMAT - FORMATO	SPESSORE THICKNESS - EPAISSEUR STÄRKE - ESPESOR	KG/MQ KG/SQ.M - KG/M2 KG/QM - KG/M2	SCATOLA BOX - BOÎTE KARTON - CAJA	EUROPALLET	
CM	MM		PZ. MQ.	BOX	MQ.

SEMIGRES					
20x20	8,2	14,70	30	1,20	75 90

NATURGRESS					
20x20	6,8	14,70	35	1,40	75 114,00

Progetto
gocommunication.it

Stampa
golinelli.it

Finito di stampare
Settembre 2006

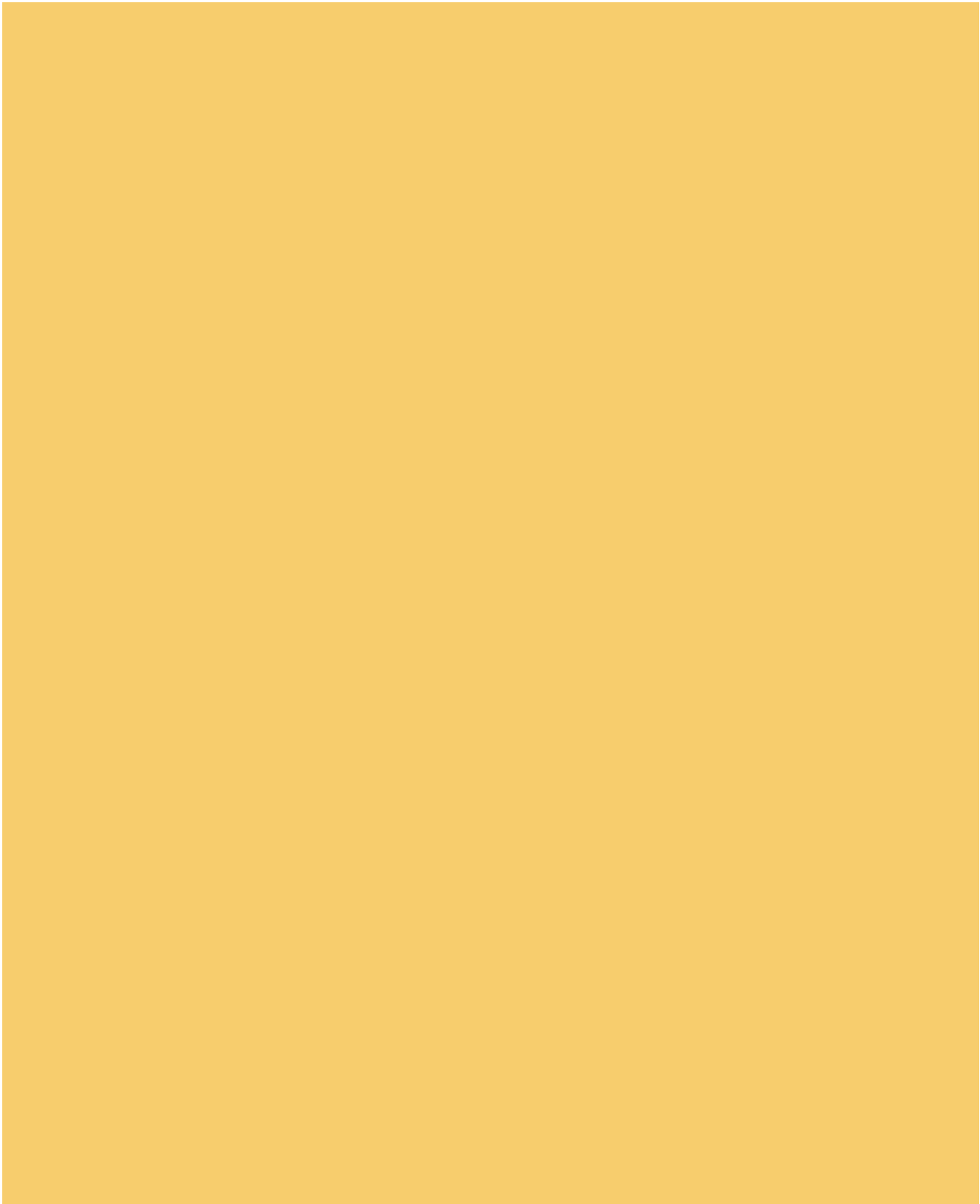

IRIS CERAMICA S p A
Via Ghiarola Nuova, 119 - Zona Industriale 1
41042 Fiorano Modenese (MO) - Italy
Telefono (60 linee): 0039(0)536-86 21 11
Telefax: 0039(0)536 80 46 02

www.irisceramica.com
promo@irisceramica.com

Numero Verde
800-738088